



SANYO

INSTRUCTION MANUAL

DWM-3500

DVD & Hi-Fi VCR Home Theater System

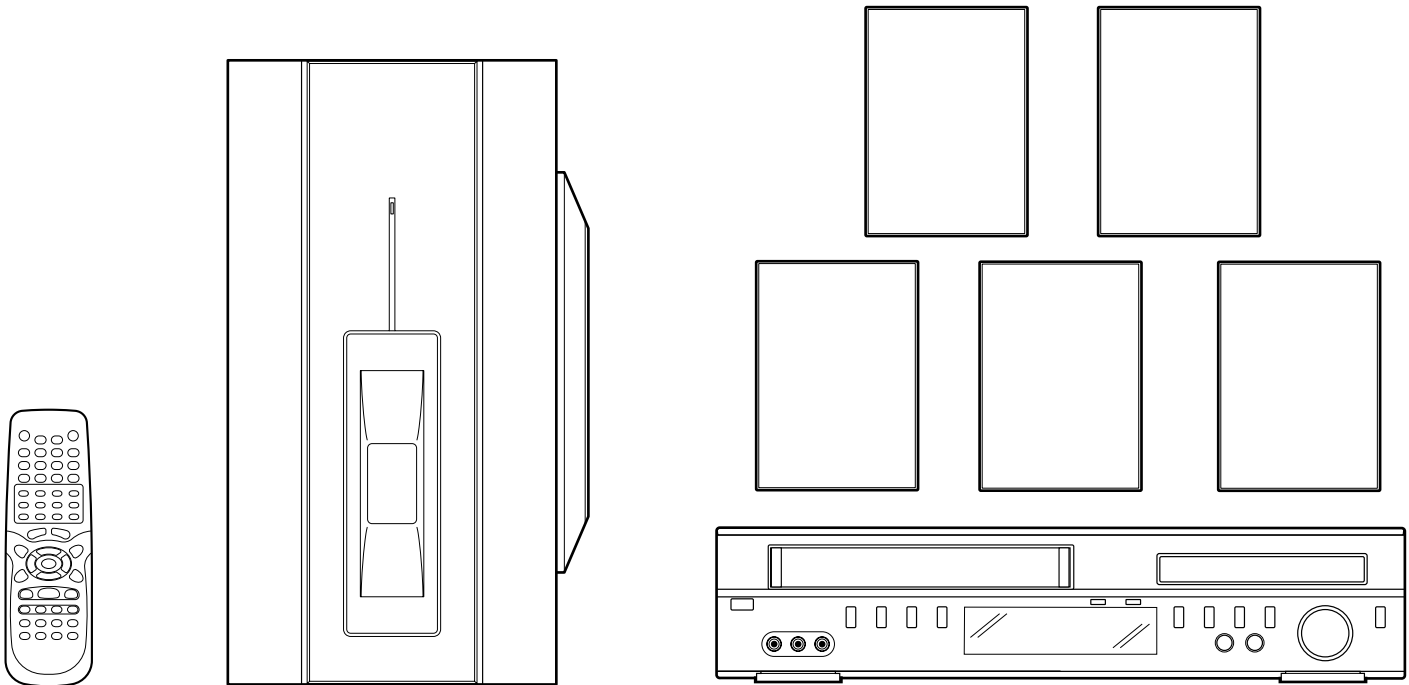

SANYO'S HELP-LINE

Call the toll-free number below if you have any difficulties operating this product.
1-800-813-3435 (Weekdays: 7:30 AM - 4:00 PM Central Time)

Please Read This Manual.

Because DVD is a new technology, we recommend that you read this manual carefully before connecting your DVD & Hi-Fi VCR Home Theater System and operating it for the first time.
Keep the manual in a safe place for future reference.

1AD6P1P1855--
DWM-3500, Issue Number 1

English

SAFETY PRECAUTIONS



WARNING
RISK OF ELECTRIC SHOCK
DO NOT OPEN



WARNING: TO REDUCE THE RISK OF ELECTRIC SHOCK DO NOT REMOVE COVER (OR BACK) NO USER-SERVICEABLE PARTS INSIDE REFER SERVICING TO QUALIFIED SERVICE PERSONNEL.



This lightning flash with arrowhead symbol within an equilateral triangle is intended to alert the user to the presence of uninsulated dangerous voltage within the product's enclosure that may be of sufficient magnitude to constitute a risk of electric shock to persons.



The exclamation point within an equilateral triangle is intended to alert the user to the presence of important operating and maintenance (servicing) instructions in the literature accompanying the product.

WARNING: TO REDUCE THE RISK OF FIRE OR ELECTRIC SHOCK, DO NOT EXPOSE THIS APPARATUS TO RAIN OR MOISTURE.

CAUTION: TO PREVENT ELECTRIC SHOCK, MATCH WIDE BLADE OF PLUG TO WIDE SLOT, FULLY INSERT.

ATTENTION: POUR ÉVITER LES CHOC ÉLECTRIQUES, INTRODUIRE LA LAME LA PLUS LARGE DE LA FICHE DANS LA BORNE CORRESPONDANTE DE LA PRISE ET POUSSER JUSQU'AU FOND.

WARNING: Do not install this equipment in a confined space such as a book case or similar unit.

NOTE TO CABLE/TV INSTALLER: This reminder is provided to call the cable TV system installer's attention to Article 820-40 of the National Electric Code (U.S.A.). The code provides guidelines for proper grounding and, in particular, specifies that the cable ground shall be connected to the grounding system of the building, as close to the point of the cable entry as practical.

CAUTION:

This main unit employs a Laser System.

To ensure proper use of this product, please read this owner's manual carefully and retain for future reference should the unit require maintenance, contact an authorized service location.

Use of controls, adjustments, or the performance of procedures other than those specified herein may result in hazardous radiation exposure.

To prevent direct exposure to laser beam, do not try to open the enclosure. Visible laser radiation when open. DO NOT STARE INTO BEAM.

To operate the built-in TVGuardian®

This unit has the built-in TVGuardian® Foul Language Filter (TVG®).

When a disc supporting closed caption is played, it will mute the audio during the entire phrase containing offensive language. For more details, see page E54.

CAUTION: The apparatus should not be exposed to water (dripping or splashing) and no objects filled with liquids, such as vases, should be placed on the apparatus.

FCC WARNING: This equipment may generate or use radio frequency energy. Changes or modifications to this equipment may cause harmful interference unless the modifications are expressly approved in the instruction manual. The user could lose the authority to operate this equipment if an unauthorized change or modification is made.

REGULATORY INFORMATION: FCC Part 15

This product has been tested and found to comply with the limits for a Class B digital device, pursuant to Part 15 of the FCC Rules. These limits are designed to provide reasonable protection against harmful interference when the product is operated in a residential installation. This product generates, uses, and can radiate radio frequency energy and, if not installed and used in accordance with the instruction manual, may cause harmful interference to radio communications. However, there is no guarantee that interference will not occur in a particular installation. If this product does cause harmful interference to radio or television reception, which can be determined by turning the product off and on, the user is encouraged to try to correct the interference by one or more of the following measures:

- Reorient or relocate the receiving antenna.
- Increase the separation between the product and receiver.
- Connect the product into an outlet on a circuit different from that to which the receiver is connected.
- Consult the dealer or an experienced radio/TV technician for help.

NOTES ON COPYRIGHTS:

It is forbidden by law to copy, broadcast, show, broadcast via cable, play in public, or rent copyrighted material without permission.

This product features the copy protection function developed by Macrovision. Copy protection signals are recorded on some discs. When recording and playing the pictures of these discs on a VCR, picture noise will appear.

This product incorporates copyright protection technology that is protected by method claims of certain U.S. patents and other intellectual property rights owned by Macrovision Corporation and other rights owners. Use of this copyright protection technology must be authorized by Macrovision Corporation, and is intended for home and other limited viewing uses only unless otherwise authorized by Macrovision Corporation. Reverse engineering or disassembly is prohibited.

Important Information:

TV, DVD, Audio CD, MP3 CD, WMA CD or VHS recorded materials are not same Audio output level. You must adjust the volume level individually.

IMPORTANT SAFETY INSTRUCTIONS

CAUTION: PLEASE READ AND OBSERVE ALL WARNINGS AND INSTRUCTIONS IN THIS OWNER'S MANUAL AND THOSE MARKED ON THE UNIT. RETAIN THIS BOOKLET FOR FUTURE REFERENCE.

This set has been designed and manufactured to assure personal safety. Improper use can result in electric shock or fire hazard. The safeguards incorporated in this unit will protect you if you observe the following procedures for installation, use, and servicing.

This unit does not contain any parts that can be repaired by the user.

DO NOT REMOVE THE CABINET COVER, OR YOU MAY BE EXPOSED TO DANGEROUS VOLTAGE. REFER SERVICING TO QUALIFIED SERVICE PERSONNEL ONLY.

1. Read These Instructions

All the safety and operating instructions should be read before the product is operated.

2. Follow All Instructions

All operating and use instructions should be followed.

3. Keep These Instructions

The safety and operating instructions should be retained for future reference.

4. Heed All Warnings

All warnings on the product and in the operating instructions should be adhered to.

5. Power Sources

This product should be operated only from the type of power source indicated on the marking label. If you are not sure of the type of power supply to your home, consult your product dealer or local power company. For products intended to operate from battery power, or other sources, refer to the operating instructions.

6. Grounding or Polarization

Do not defeat the safety purpose of the polarized plug has two blades with one wider than the other. A grounding-type plug has two blades and a third grounding prong. The wide blade or the prong are provided for your safety. If the provided plug does not fit into your outlet, consult an electrician for replacement of the obsolete outlet.

7. Ventilation

Slots and openings in the cabinet are provided for ventilation and to ensure reliable operation of the product and to protect it from overheating. These openings must not be blocked or covered. The openings should never be blocked by placing the product on a bed, sofa, rug or other similar surface. This product should not be placed in a built-in installation such as a bookcase or rack unless proper ventilation is provided or the manufacturer's instructions have been adhered to.

8. Heat

The product should be situated away from heat sources such as radiators, heat registers, stoves, or other products (including amplifiers) that produce heat.

9. Water and Moisture

Do not use this product near water – for example, near a bath tub, wash bowl, kitchen sink, or laundry tub, in a wet basement, or near a swimming pool.

10. Cleaning

Unplug this product from the wall outlet before cleaning. Do not use liquid cleaners or aerosol cleaners. Use a damp cloth for cleaning.

11. Power-Cord Protection

Power-supply cords should be routed so that they are not likely to be walked on or pinched by items placed upon or against them, paying particular attention to cords at plugs, convenience receptacles, and the point where they exit from the product.

12. Overloading

Do not overload wall outlets, extension cords, or integral convenience receptacles, this can result in a risk of fire or electric shock.

13. Outdoor Antenna Grounding

If an outside antenna or cable system is connected to the product, be sure the antenna or cable system is grounded so as to provide some protection against voltage surges and built-up static charges. Article 810 of the National Electrical Code (U.S.A.), ANSI/NFPA 70 provides information with regard to proper grounding of the mast and supporting structure, grounding of the lead-in wire to an antenna discharge unit, size of grounding conductors, location of antenna-discharge unit, connection to grounding electrodes, and requirements for the grounding electrode.

EXAMPLE OF GROUNDING ACCORDING TO NATIONAL ELECTRICAL CODE INSTRUCTIONS

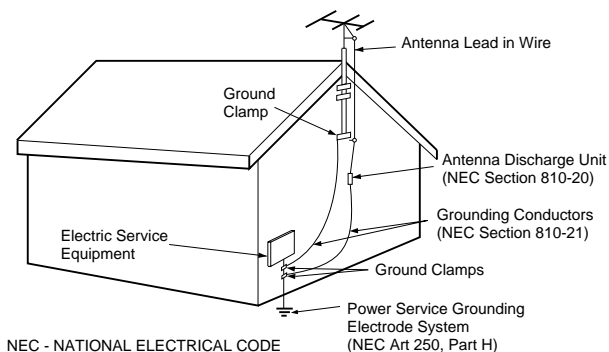

14. Lightning

Unplug this apparatus during lightning storms or when unused for long periods of time. This will prevent damage to the product due to lightning and power-line surges.



15. Power Lines

An outside antenna system should not be located in the vicinity of overhead power lines or other electric light or power circuits, or where it can fall into such power lines or circuits. When installing an outside antenna system, extreme care should be taken to keep from touching such power lines or circuits as contact with them might be fatal.

16. Object and Liquid Entry

Never push objects of any kind into this product through openings as they may touch dangerous voltage points or short-out parts that could result in a fire or electric shock. Never spill liquid of any kind on the product.

17. Attachments

Do not use attachments not recommended by the product manufacturer as they may cause hazards.

18. Accessories

Do not place this product on an unstable cart, stand, tripod, bracket, or table. The product may fall, causing serious injury to a child or adult, and serious damage to the product. Use only with a cart, stand, tripod, bracket, or table recommended by the manufacturer, or sold with the product. Any mounting of the product should follow the manufacturer's instructions, and should use a mounting accessory recommended by the manufacturer.



19. Damage Requiring Service

Unplug this product from the wall outlet and refer servicing to qualified service personnel under the following conditions:

- a. If the power-supply cord or plug is damaged.
- b. If liquid has been spilled, or objects have fallen into the product.
- c. If the product has been exposed to rain or water.
- d. If the product does not operate normally by following the operating instructions. Adjust only those controls that are covered by the operating instructions as an improper adjustment of other controls may result in damage and will often require extensive work by a qualified technician to restore the product to its normal operation.
- e. If the product has been dropped or the cabinet has been damaged.
- f. If the product exhibits a distinct change in performance.

20. Servicing

Do not attempt to service this product yourself as opening or removing the cover may expose you to dangerous voltage or other hazards. Refer all servicing to qualified service personnel.

21. Replacement parts

When replacement parts are required, be sure the service technician has used replacement parts specified by the manufacturer or have the same characteristics as the original part. Unauthorized substitutions may result in fire, electric shock, or other hazards.

22. Safety Check

Upon completion of any service or repairs to this product, ask the service technician to perform safety checks to determine that the product is in proper operating condition.

23. Disc Tray

Keep your fingers well clear of the disc tray as it is closing. It can cause personal injury.

24. Burden

Do not place a heavy object on or step on the product. The object may fall, causing serious personal injury and serious damage to the product.

25. Connecting

When you connect the product to other equipment, turn off the power and unplug all of the equipment from the wall outlet. Failure to do so may cause an electric shock and serious personal injury. Read the owner's manual of the other equipment carefully and follow the instructions when making any connections.

26. Sound Volume

Reduce the volume to the minimum level before you turn on the product. Otherwise, sudden high volume sound may cause hearing or speaker damage.

27. Sound Distortion

Do not allow the product to output distorted sound for a longtime. It may cause speaker overheating and fire.

28. Earphone

When you use the earphone, keep the volume at a moderate level. If you use the earphone continuously with high volume sound, it may cause hearing damage.

29. Laser Beam

Do not look into the opening of the disc tray or ventilation opening of the product to see the source of the laser beam. It may cause sight damage.

30. Disc

Do not use a cracked, deformed, or repaired disc. These discs are easily broken and may cause serious personal injury and product malfunction.

CONDENSATION

Moisture will form in the operating section of the unit if the unit is brought from cool surroundings into a warm room or if the temperature of the room rises suddenly. When this happens, the unit's performance will be impaired.

To prevent this, let the unit stand in its new surroundings for approximately an hour before switching it on, or make sure that the room temperature rises gradually.

Condensation may also form during the summer if the unit is exposed to the breeze from an air conditioner. In such cases, change the location of the unit.



CONTENTS

SAFETY PRECAUTIONS	E1	Title Search [DVD]	E42
IMPORTANT SAFETY INSTRUCTIONS	E2	Chapter Search [DVD]	E42
CONTENTS	E4	Time Search [DVD]	E42
ACCESSORIES	E5	Time Search [CD]	E43
PRECAUTIONS	E5	Track Search [CD]	E43
CONTROLS	E6	Fast Playback	E44
Front Panel	E6	Slow Motion Playback [DVD]	E44
FL Display	E6	Still Picture (Pause)	E44
Rear Panel	E6	Frame by Frame Advance Playback [DVD]	E45
REMOTE CONTROL	E7	Picture Zoom [DVD]	E45
Controls	E7	Viewing from a Desired Camera Angle (Multi-Angle)	
Inserting Batteries	E8	[DVD]	E45
Remote Control Range	E8	Normal Repeat Playback	E46
To Set the Remote Control Code for TV	E8	Designated Range Repeat Playback (A-B Repeat)	E46
BASIC CONNECTIONS	E9	Random Playback [CD] [MP3] [WMA] [JPEG]	E47
TV Antenna Connections	E9	Programmed Playback [CD] [MP3] [WMA] [JPEG]	E47
Basic TV Connections	E10	Selecting Subtitle Language [DVD]	E48
Audio/Video Connection	E10	Selecting Audio Soundtrack Language	
Optional, Preferred TV Connections	E11	(Multi-Language) [DVD]	E48
CATV (CABLE TV) Connections	E12	Karaoke Playback [DVD]	E48
Speaker Connections	E14	Selecting On-Screen Information	E49
Speaker Placement	E15	Marking Desired Scenes [DVD] [CD]	E49
AM/FM Antenna Connections	E16	MP3/WMA CD OPERATION	E50
Power Supply (Main Unit and Powered Subwoofer)	E16	Before Starting	E50
ADJUSTING THE CLOCK	E17	MP3/WMA CD Playback	E50
Auto Clock Setting	E17	Stopping Playback	E51
Manual Clock Setting	E19	Pause	E51
BEFORE OPERATION	E20	File (Track) Skip	E51
Common Operation	E20	Repeat Playback	E51
Selecting Surround Mode	E21	PICTURE DISC OPERATION	E52
Adjusting the Speaker Volume Balance	E22	KODAK Picture CD Playback	E52
Adjusting the Speaker and Subwoofer Level	E22	JPEG CD Playback	E53
Changing the Delay Time	E23	TVGuardian® OPERATION	E54
Setting the Video Channel	E24	Set the TVG MODE to ON Mode	
Setting the Language	E24	(TOLERANT, MODERATE, STRICT)	E54
VCR Tuner Setting	E25	DVD SPEAKER MUTE Setting	E55
To ADD/DELETE Channels	E26	CC (Closed Caption) DISPLAY Setting	
Noise Elimination	E26	with TVG MODE is Set to ON Mode	E55
VIDEO CASSETTE TAPE PLAYBACK	E27	CC (Closed Caption) DISPLAY Setting	
Loading and Unloading a Cassette Tape	E27	with TVG MODE is Set to OFF Mode	E55
Basic Playback	E28	INITIAL SETTINGS	E56
Special Playback	E29	Setting Language	E56
ZERO RETURN Function	E30	Setting OSD Language	E56
Video Index Search System	E30	Setting Picture	E57
RECORDING	E31	Setting Sound	E58
Recording a TV Program	E31	Setting Parental	E59
One-touch Timer Recording (OTR)	E33	To Change the Parental Level	E59
Timer Recording	E34	LANGUAGE CODE LIST	E60
Stereo Recording and Playback	E36	LISTENING TO THE RADIO	E61
Separate Audio Program (SAP)	E36	Automatic/Manual Tuning	E61
Duplicating a Video Tape	E37	To Preset Stations	E61
Recording a DVD/CD Disc	E37	Listening to Preset Stations	E62
PLAYABLE DISCS	E38	TROUBLESHOOTING GUIDE	E63
DISC PLAYBACK	E39	MAINTENANCE	E65
Preparations	E39	Cleaning the Cabinet	E65
Basic Playback	E39	Video Head Cleaning	E65
Stopping Playback	E40	SPECIFICATIONS	E66
Chapter (Track) Skip	E40	WARRANTY	back cover
Selecting a DVD Menu	E41		
Selecting a Title Menu [DVD]	E41		



ACCESSORIES

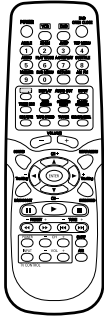

Wireless remote control

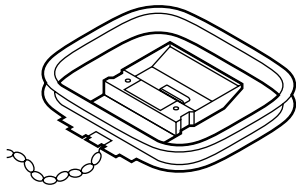

AM loop antenna



FM indoor antenna lead wire

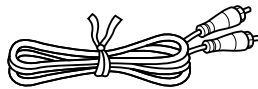

Video cable

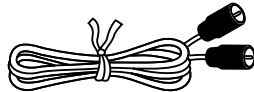

75 ohm antenna coaxial cable

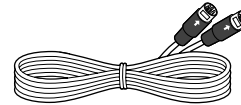

Powered subwoofer cable
(Din 9-pin cable)

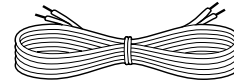

Front right speaker cable
(Black and Red)

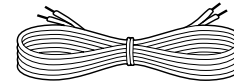

Front left speaker cable
(Black and White)

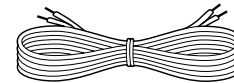

Center speaker cable
(Black and Green)

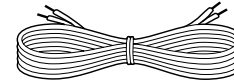

Surround right speaker cable
(Black and Gray)

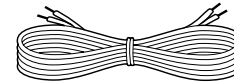

Surround left speaker cable
(Black and Blue)

Note:
The speaker cables are packed in the speaker package.

PRECAUTIONS

Handling the unit

When shipping the unit

The original shipping carton and packing materials come in handy. For maximum protection, re-pack the unit as it was originally packaged at the factory.

When setting up the unit

The picture and sound of a nearby TV, VCR, or radio may be distorted during playback. In this case, position the unit away from the TV, VCR, or radio, or turn off the unit after removing the disc.

To keep the surface clean

Do not use volatile liquids, such as insecticide spray, near the unit. Do not leave rubber or plastic products in contact with the unit for a long period of time. They will leave marks on the surface.

Cleaning the unit

To clean the cabinet

Use a clean soft cloth moistened with plain lukewarm water and wrung dry. Never use benzol, benzene or other strong chemical cleaners since these could damage the finish of your unit. It is important that no liquid reaches the inside of the unit.

To obtain a clear picture

The main unit is a high-tech, precision device. If the optical pick-up lens and disc drive parts are dirty or worn, the picture quality will be poor.

Regular inspection and maintenance are recommended after every 1,000 hours of use. (This depends on the operating environment.)

For details, please contact your nearest dealer.

CAUTION:

The main unit and powered subwoofer must be placed in a well ventilated area.

Do not place any object on the top of the unit.

Do not block ventilation holes.

The cabinet of the unit warms up when it is used for a long time, but it is not a malfunction.

WHAT TO DO IF...

If the operation of the unit or display is not normal, even though the appropriate buttons have been pressed.

Unplug the unit from the wall outlet, wait a few minutes, and plug it back in.

Note:

If the unit still does not operate correctly, please contact your nearest Sanyo Authorized Service Facility.



CONTROLS

Front Panel

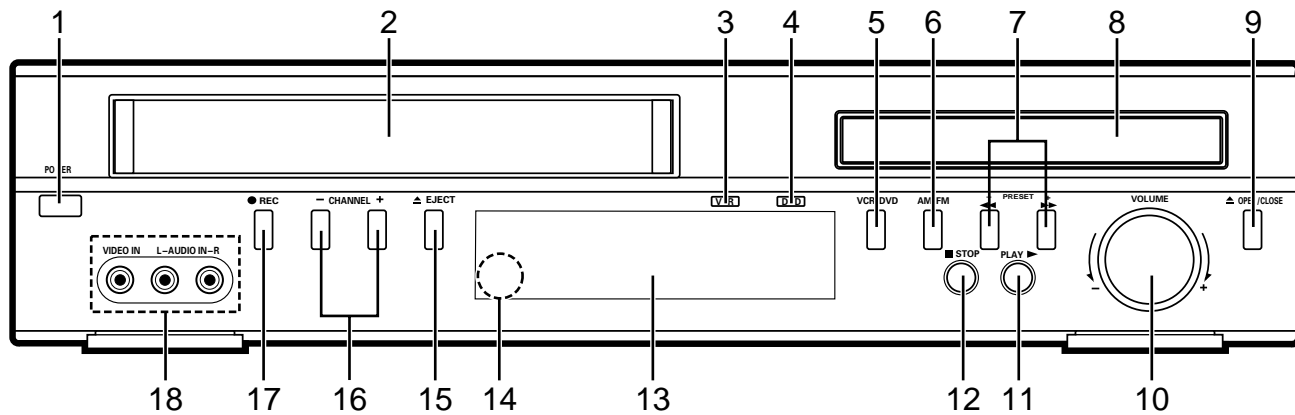

- | | | |
|---------------------------------|----------------------------|--------------------------------|
| 1. POWER button | 7. ◀▶ (PRESET +/-) buttons | 13. FL display |
| 2. Cassette loading slot | 8. Disc tray | 14. Remote sensor (IR) |
| 3. VCR indicator | 9. OPEN/CLOSE button | 15. EJECT button |
| 4. DVD indicator | 10. VOLUME control | 16. CHANNEL +/- buttons |
| 5. VCR/DVD mode selector button | 11. PLAY button | 17. REC button |
| 6. AM/FM button | 12. STOP button | 18. AUDIO (L/R)/VIDEO IN jacks |

FL Display

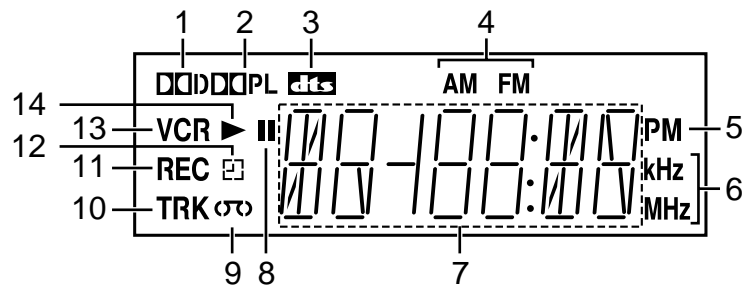

- | | |
|---|--|
| 1. Dolby Digital indicator (Dolby Digital symbol) | 8. Pause indicator (II) |
| 2. Dolby Pro Logic indicator (Dolby Pro Logic symbol) | 9. Video tape indicator (VCR symbol) |
| 3. *DTS indicator (DTS symbol) | 10. Track indicator (TRK symbol) |
| 4. AM/FM indicators | 11. REC indicator |
| 5. AM/PM indicator (AM is not displayed) | 12. Timer recording indicator (Timer symbol) |
| 6. Kilohertz/Megahertz indicators | 13. VCR indicator |
| 7. Message or number indicators
(Title, chapter, track, playing time or other information) | 14. Play indicator (▶) |

"DTS" and "DTS Digital Out" are trademarks of Digital Theater Systems, Inc.

Manufactured under license from Dolby Laboratories.

"Dolby", "Pro Logic" and the double-D symbol are trademarks of Dolby Laboratories.

***DVD video disc with DTS may not work correctly. You can see the picture on the TV screen, but there is no sound.**

Rear Panel

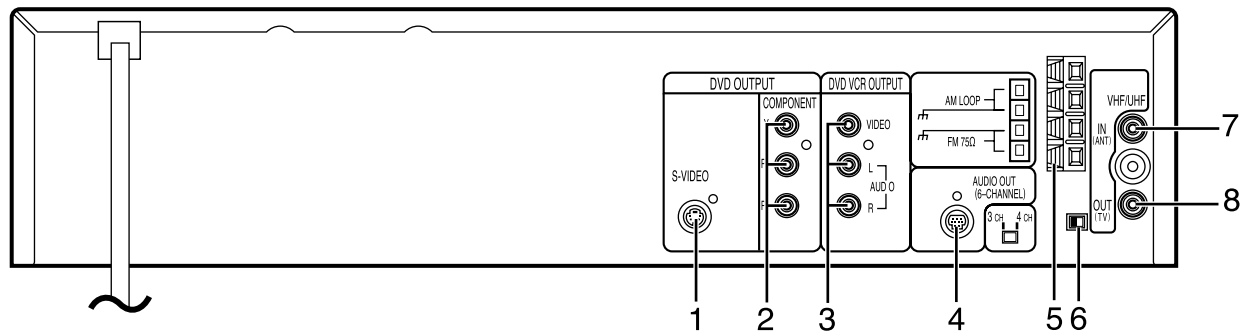

- | | |
|--|--|
| 1. DVD S-Video output jack (S-VIDEO) | 5. AM/FM antenna terminals |
| 2. DVD component video output jacks (COMPONENT) | 6. Channel selector switch (3 CH/4 CH) |
| 3. Video/Audio output jacks (VIDEO/AUDIO) | 7. RF IN jack |
| 4. Audio output jack for powered subwoofer (AUDIO OUT) | 8. RF OUT jack |



REMOTE CONTROL

Controls

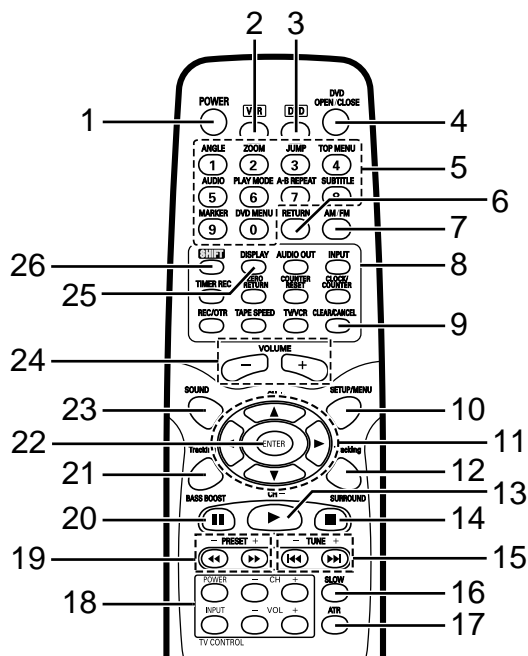

1. POWER button (E17, 20, 24, 39)
2. VCR button (E17, 20, 24)
3. DVD button (E20, 37, 39)
4. DVD OPEN/CLOSE button (E39, 50, 52)
5. Number and other function buttons
These buttons are used as number buttons and as function buttons of each name.
 - When using as a number button, press the appropriate button directly.
Number buttons (1-9, 0)
(E8, 31, 33, 42, 43, 47, 51, 59, 62)
 - When using as a function button of each name, press the appropriate button while holding the SHIFT button down.
ANGLE button (E45, 52, 53)
ZOOM button (E45, 52, 53)
JUMP button (E42)
TOP MENU button (E41, 52, 53)
AUDIO button (E48)
PLAY MODE button (E46, 47)
A-B REPEAT button (E46)
SUBTITLE button (E48)
MARKER button (E49)
DVD MENU button (E41, 52, 53)

6. RETURN button (E56 ~ 59)
 7. AM/FM button (E20, 61, 62)
 8. VCR control buttons
AUDIO OUT button (E36)
INPUT button (E20, 37)
TIMER REC button (E34)
ZERO RETURN button (E30)
COUNTER RESET button (E30)
CLOCK/COUNTER button (E30)
REC/OTR (Recording/One-touch Timer Recording) button (E31, 33, 37)
TAPE SPEED button (E31, 33, 37)
TV/VCR button (E17, 24, 32)
 9. CLEAR/CANCEL button (E19, 34, 35, 42, 43, 47, 49, 59)
 10. SETUP/MENU button (E17, 19, 22 ~ 26, 34 ~ 36, 52 ~ 59, 61, 62)
 11. Directional arrow buttons (▲, ►, ▼, ◀)
(E17 ~ 20, 22 ~ 26, 31, 34 ~ 36, 41 ~ 43, 45 ~ 49, 51 ~ 59)
CH (Channel) +/- buttons (E31, 33)
Tracking +/- buttons (E29)
 12. SURROUND button (E21)
 13. Play button (▶) (E28, 29, 37, 39 ~ 41, 44 ~ 47, 51)
 14. Stop button (■) (E28, 30, 32, 33, 37, 40, 51)
 15. ◀◀▶▶ buttons (E30, 40, 51-53)
Tuning buttons (- TUNE +) (E61)
 16. SLOW button (E29, 44)
 17. ATR (Automatic tracking) button (E29)
 18. TV control buttons (E8)
POWER button
INPUT select button
Channel scanning buttons (- CH +)
Volume buttons (- VOL +)
 19. ◀◀▶▶ buttons (E28, 29, 44)
Preset tuning buttons (- PRESET +) (E62)
 20. Pause button (⏸) (E29, 32, 37, 45, 51 ~ 53)
 21. BASS BOOST button (E20)
 22. ENTER button (E17 ~ 20, 22 ~ 26, 34 ~ 36, 41 ~ 43, 46, 47, 49, 51 ~ 59, 62)
 23. SOUND button (E20)
 24. VOLUME buttons (- VOLUME +) (E20, 22)
 25. DISPLAY button (E30, 32, 49)
 26. SHIFT button (E41 ~ 43, 45 ~ 49, 51 ~ 53)
- Explanations are found on the page number(s) in parenthesis.



Inserting Batteries

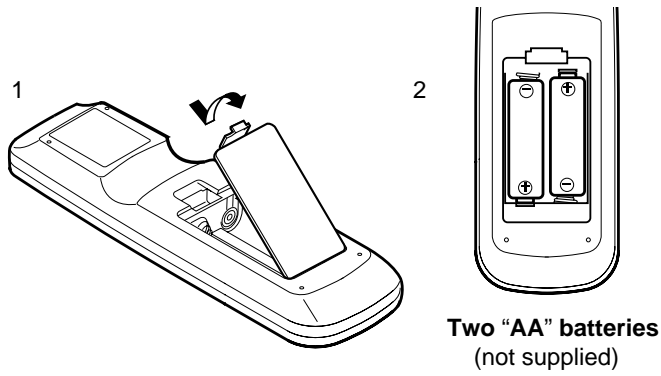

Note:

Remove the batteries if the remote control is not to be used for a month or more. Batteries left in the unit may leak and cause damage.

IMPORTANT NOTE:

SPENT OR DISCHARGED BATTERIES MUST BE RECYCLED OR DISPOSED OF PROPERLY IN COMPLIANCE WITH ALL APPLICABLE LAWS. FOR DETAILED INFORMATION, CONTACT YOUR LOCAL COUNTY SOLID WASTE AUTHORITY.

To Set the Remote Control Code for TV

This remote control can operate the basic functions of TVs made by the manufacturers listed below.

To enter the remote control code for your brand of TV, follow the steps below.

- In the chart below, find the code corresponding to your brand of TV.
- While holding down [(TV CONTROL) POWER], enter the 2-digit code using the number buttons [0–9], then release [(TV CONTROL) POWER].
 - The remote control is now set to operate your TV.

TV brands	Code
ADMIRAL	05, 10, 13
EMERSON	17
FISHER	03
GE	07
GOLD STAR	01
HITACHI	02
JVC	15
MAGNAVOX	08
MATSUSHITA	12, 18
MITSUBISHI	14
PANASONIC	12, 18
QUASAR	12, 18
RCA	06
SAMSUNG	16
SANYO	03
SHARP	00, 13
SONY	11
TECHNOL ACE	05
TOSHIBA	04
ZENITH	09, 10

Remote Control Range

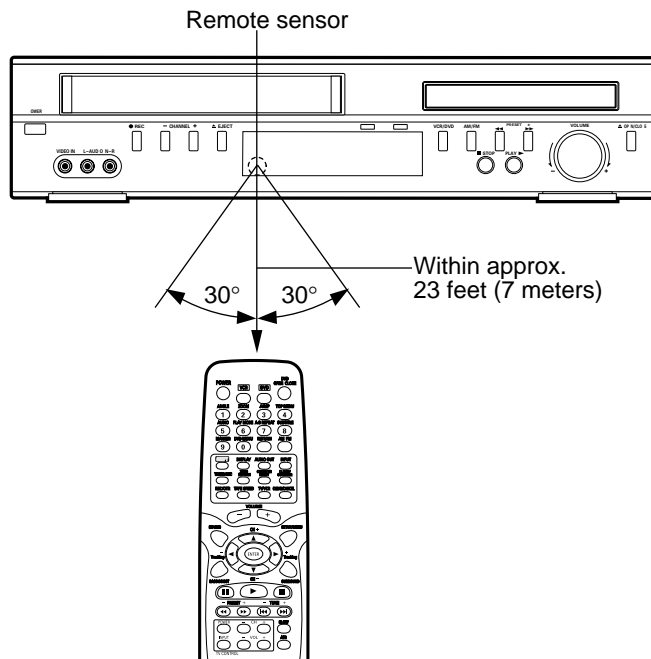

Number buttons

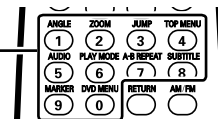

(TV CONTROL) POWER

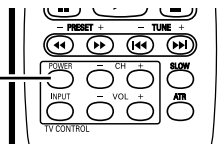

Notes:

- Only remote-controlled TVs can be operated using this remote control. (Refer to your TV instruction manual for more details.)
- There may be some TV models that cannot be operated with this remote control. If this is the case, use the original remote control supplied with the TV.

IMPORTANT NOTE:

If the batteries in the remote control are changed, the code settings for the TV must be re-entered.

Write your code number below for future reference.

TV: _____

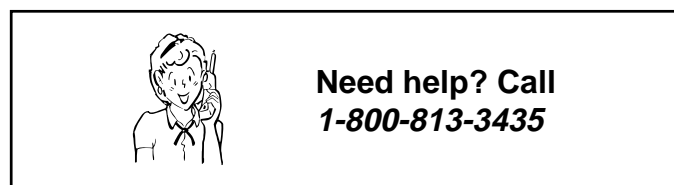

BASIC CONNECTIONS

Note:

Do not connect the power cord to a 120V AC 60Hz outlet until all connections have been made.

TV Antenna Connections

If you are using an antenna system, follow these instructions. If you are a cable (CATV) subscriber, skip ahead to page E12 for the proper connections.

The main unit must be connected "between" the antenna and the TV. First, disconnect the antenna from the TV and connect it to the main unit. Then connect the main unit to the TV. Below are 3 common methods of connecting an antenna system to a main unit. Find the type of antenna system you are using and follow the connection diagram.

Example 1: Combination VHF/UHF antenna with 75 ohm coaxial cable

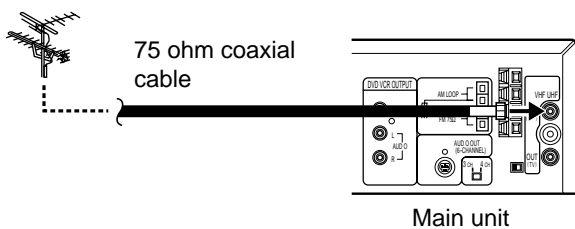

Example 2: Combination VHF/UHF antenna with 300 ohm twin lead (flat) wire

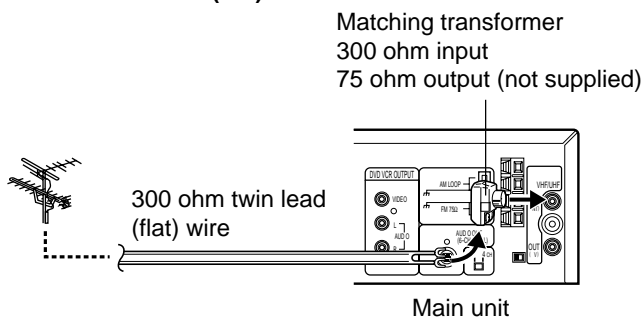

Example 3: Separate VHF and UHF antennas

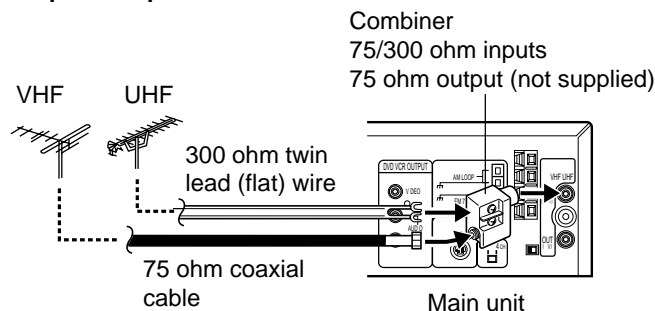

Note:

If both VHF and UHF antennas have 300 ohm twin lead (flat) wires, use a combiner having two 300 ohm inputs and one 75 ohm output.

Notes:

- A clear picture will not be obtained by the main unit unless the antenna signal is good. Connect the antenna to the main unit properly.
- For better quality recording, an indoor antenna or a telescopic antenna is not recommended. The use of an outdoor type antenna is required.
- If you are not sure about the connection, please refer to qualified service personnel.



Basic TV Connections

After you have connected the antenna to the main unit, you must connect the main unit to the TV.

Below are 3 common methods of connecting your main unit to a TV. Find the type of TV you are using and follow the connection diagram.

This main unit has a single 75 ohm output for connection to a TV. If your TV has separate VHF and UHF antenna inputs (Examples 2 and 3 below), use a splitter to connect the main unit to the TV for VHF and UHF reception.

Example 1: TV with single 75 ohm VHF/UHF antenna input

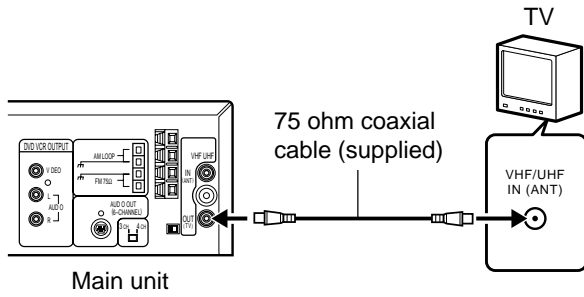

Note:

If a VHF or UHF antenna is used, set the TV/CATV menu option to the "TV" mode. (See "TV/CATV selection" on page E25.)

Example 2: TV with 300 ohm UHF and 75 ohm VHF antenna inputs

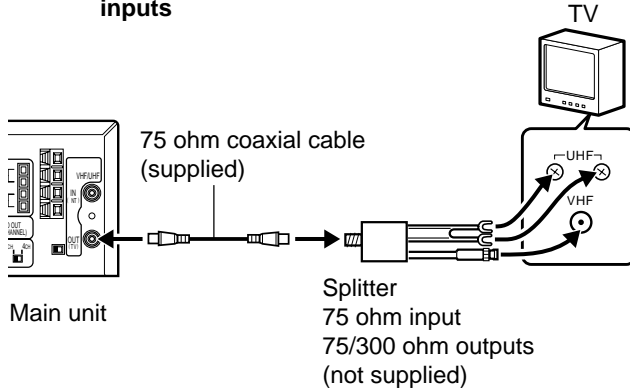

Note:

If a VHF or UHF antenna is used, set the TV/CATV menu option to the "TV" mode. (See "TV/CATV selection" on page E25.)

Example 3: TV with 300 ohm UHF and 300 ohm VHF antenna inputs

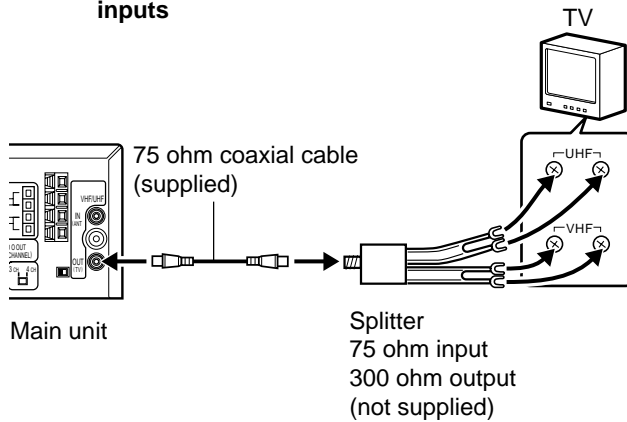

Note:

If a VHF or UHF antenna is used, set the TV/CATV menu option to the "TV" mode. (See "TV/CATV selection" on page E25.)

Audio/Video Connection

1. Connect the DVD/VCR OUTPUT VIDEO jack on the main unit to the video input jack on the TV using the video cable supplied.
2. If you use your TV's speaker, connect the DVD/VCR OUTPUT AUDIO L/R jacks on the main unit to the audio left/right input jacks on the TV using an audio cables (not supplied).

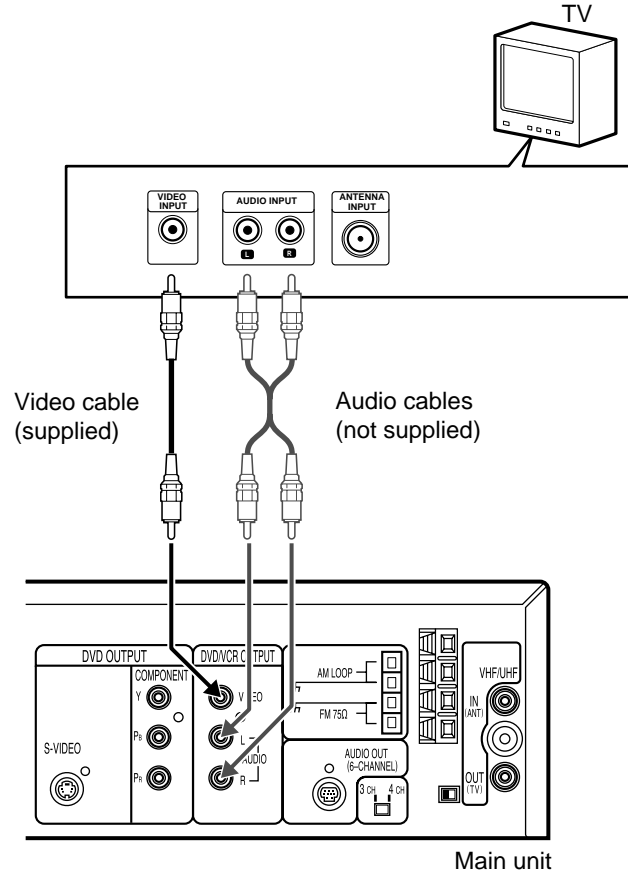

Note:

If you use this connection, set the TV's source selector to VIDEO.



**Need help? Call
1-800-813-3435**

Optional, Preferred TV Connections

Note:

You can **ONLY** watch DVD playback through the connections shown below.

S-Video connection

1. Connect the DVD OUTPUT S-VIDEO jack on the main unit to the S-video input jack on the TV using the S-video cable (not supplied).
2. If you use your TV's speaker, connect the DVD/VCR OUTPUT AUDIO L/R jacks of the main unit to the audio left/right input jacks on the TV using an audio cables (not supplied).

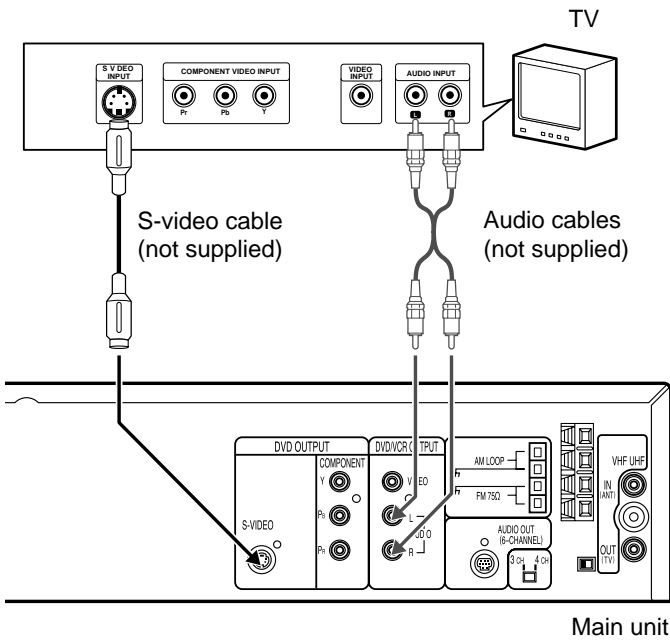

Notes:

- You can enjoy clearer picture playback (DVD).
- VCR on-screen information and video do not appear on the TV screen.

Component video connection

1. Connect the DVD OUTPUT COMPONENT jacks on the main unit to the corresponding input jacks on the TV using the component video cables (not supplied).
2. If you use your TV's speaker, connect the DVD/VCR OUTPUT AUDIO L/R jacks of the main unit to the audio left/right input jacks on the TV using an audio cables (not supplied).

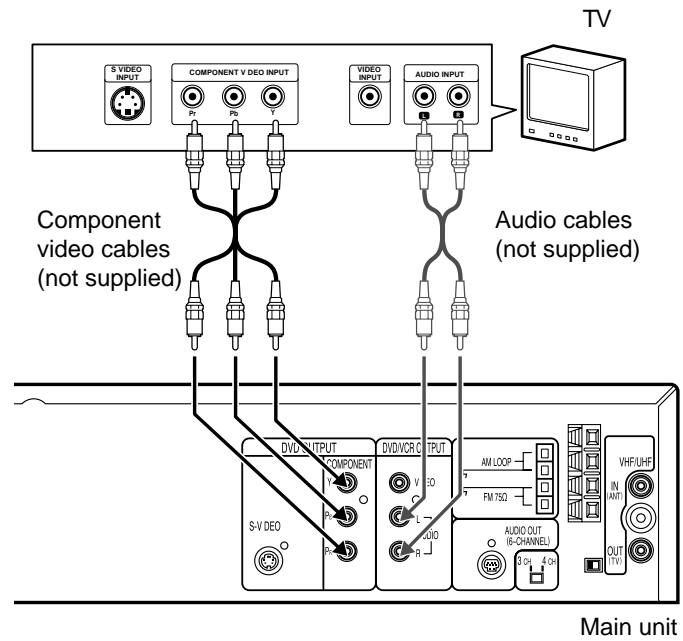

Notes:

- You can enjoy high quality picture playback (DVD).
- VCR on-screen information and video do not appear on the TV screen.



CATV (CABLE TV) Connections

Many cable companies offer services permitting reception of extra channels including pay or subscription channels. The main unit has an extended tuning range and can be tuned to most cable channels without using a cable company supplied converter box, except for those channels which are intentionally scrambled. If you subscribe to a special channel which is scrambled, you must have a descrambler box for proper reception.

IMPORTANT:

Make sure the TV/CATV menu option is set to the "CATV" mode. This unit cannot receive scrambled programs since it does not contain a descrambler. In order to receive scrambled programs, your existing descrambler must be used. Descrambler boxes are available from cable companies. Consult your local cable company for more information concerning connection to their descrambler equipment. There are many ways to connect your unit to a cable system. Below are six common methods of connection.

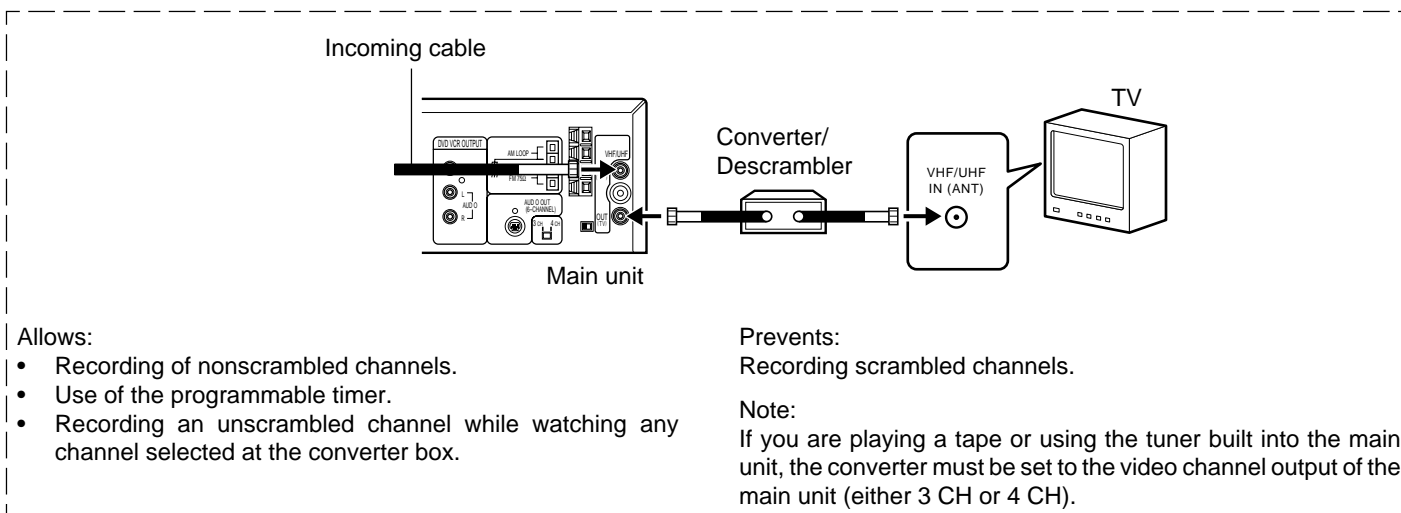
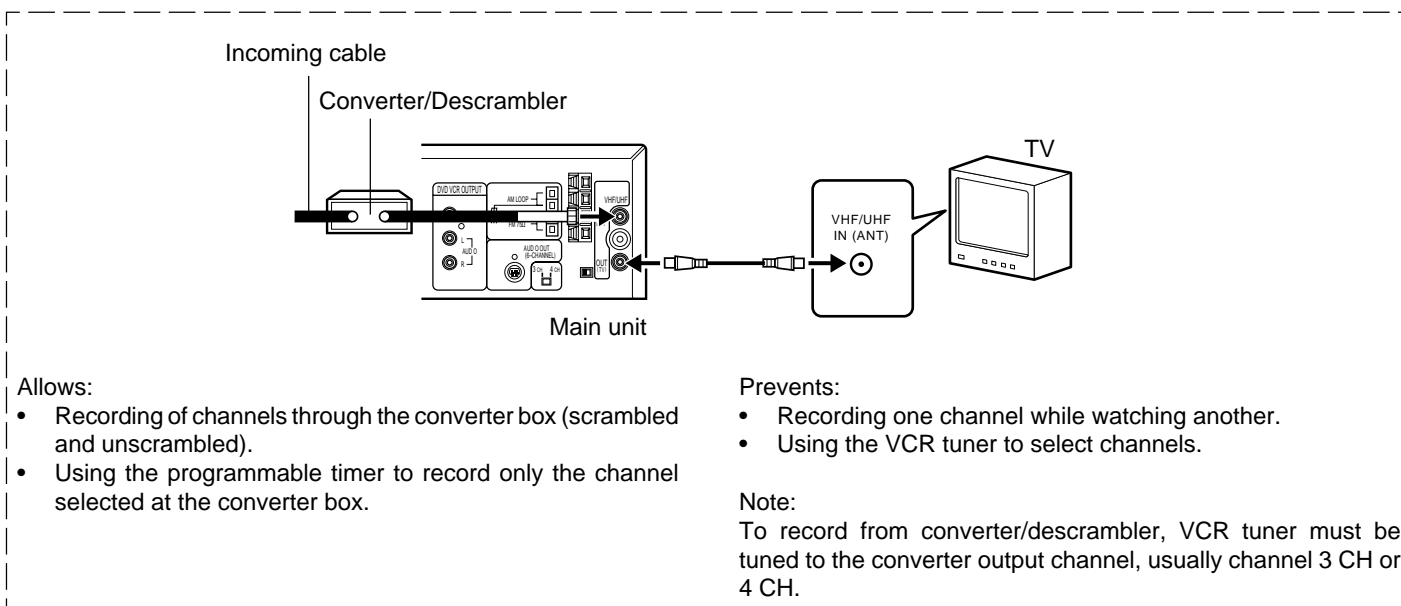
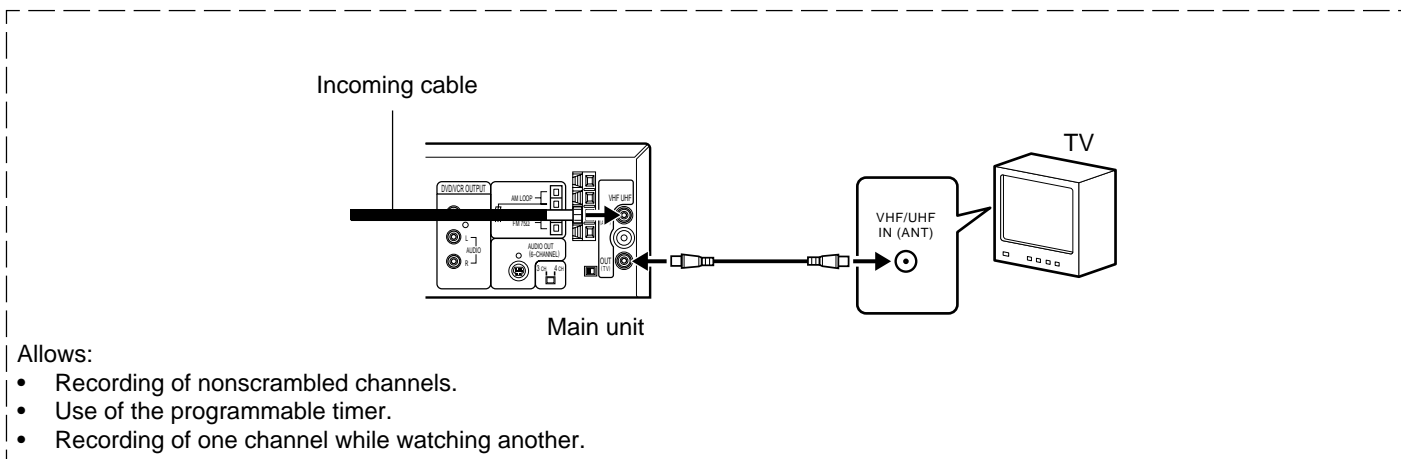

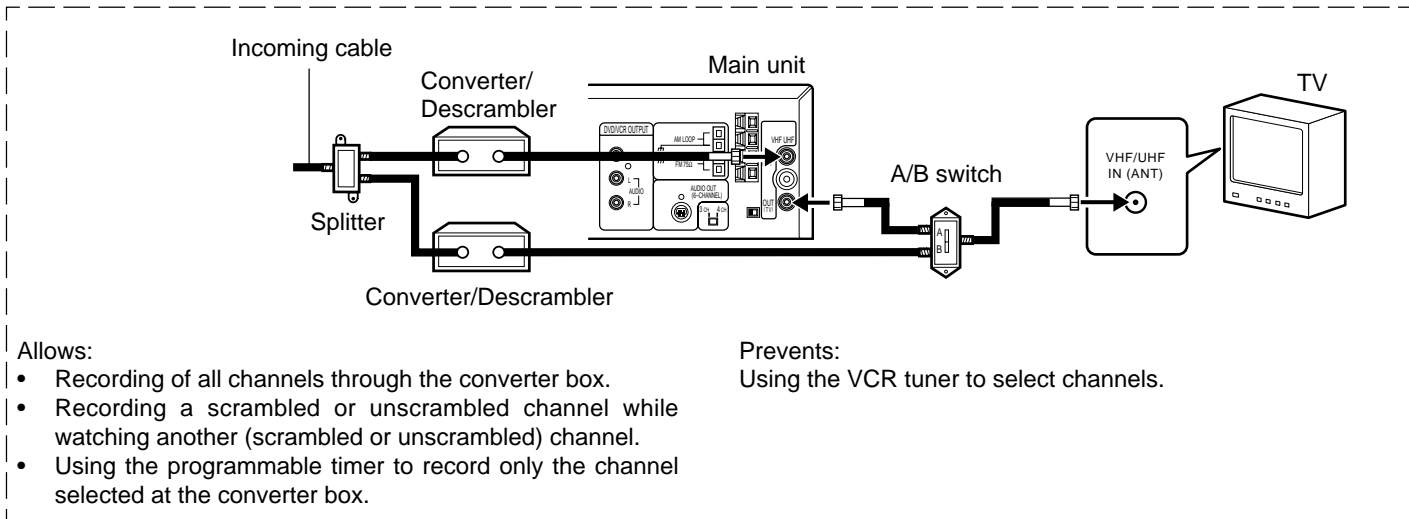
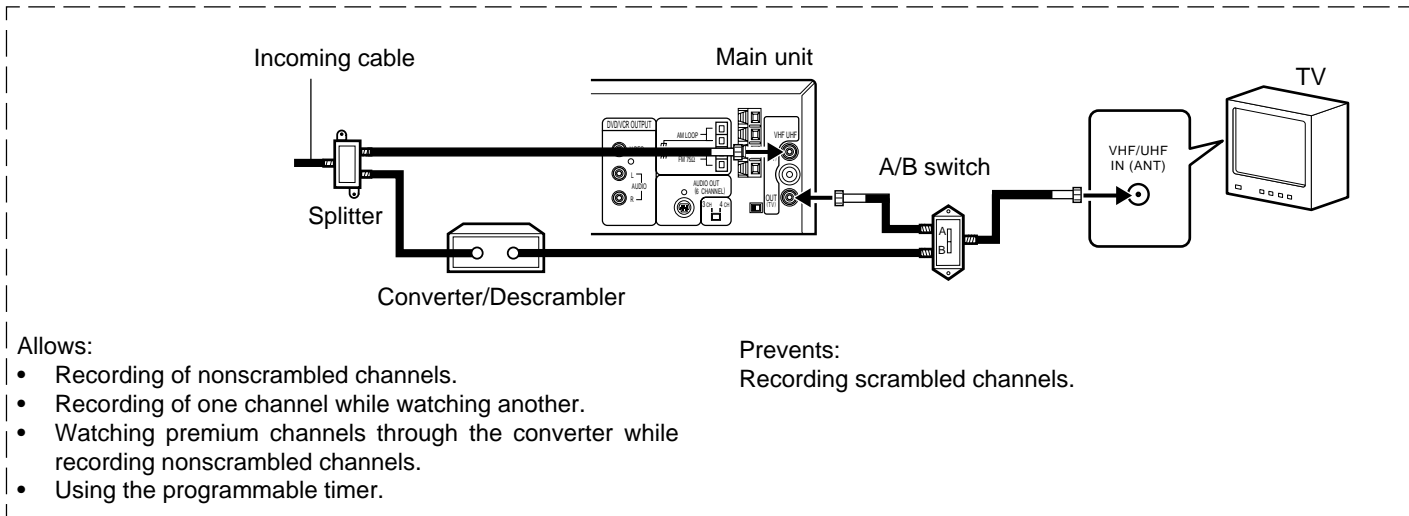
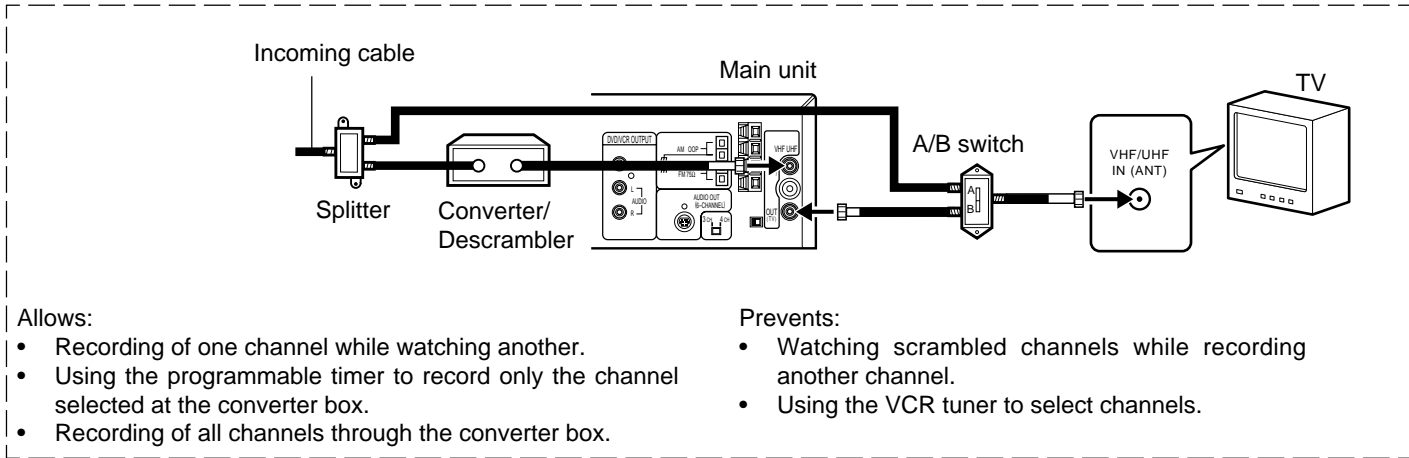

Note:
Whenever a Converter/Descrambler box is placed before the main unit, you must tune the VCR tuner to the output of the Converter/Descrambler box, usually channel 3 or 4.

**Need help? Call
1-800-813-3435**





Speaker Connections

To achieve proper stereo reproduction, connect the speaker wires without shorting to adjacent wires as shown below.

Note:

Do not connect the power cord to a 120V AC 60Hz outlet until all connections have been made.

Speaker wire color	Use
Black and White	Front left speaker
Black and Red	Front right speaker
Black and Green	Center speaker
Black and Blue	Surround left speaker
Black and Gray	Surround right speaker

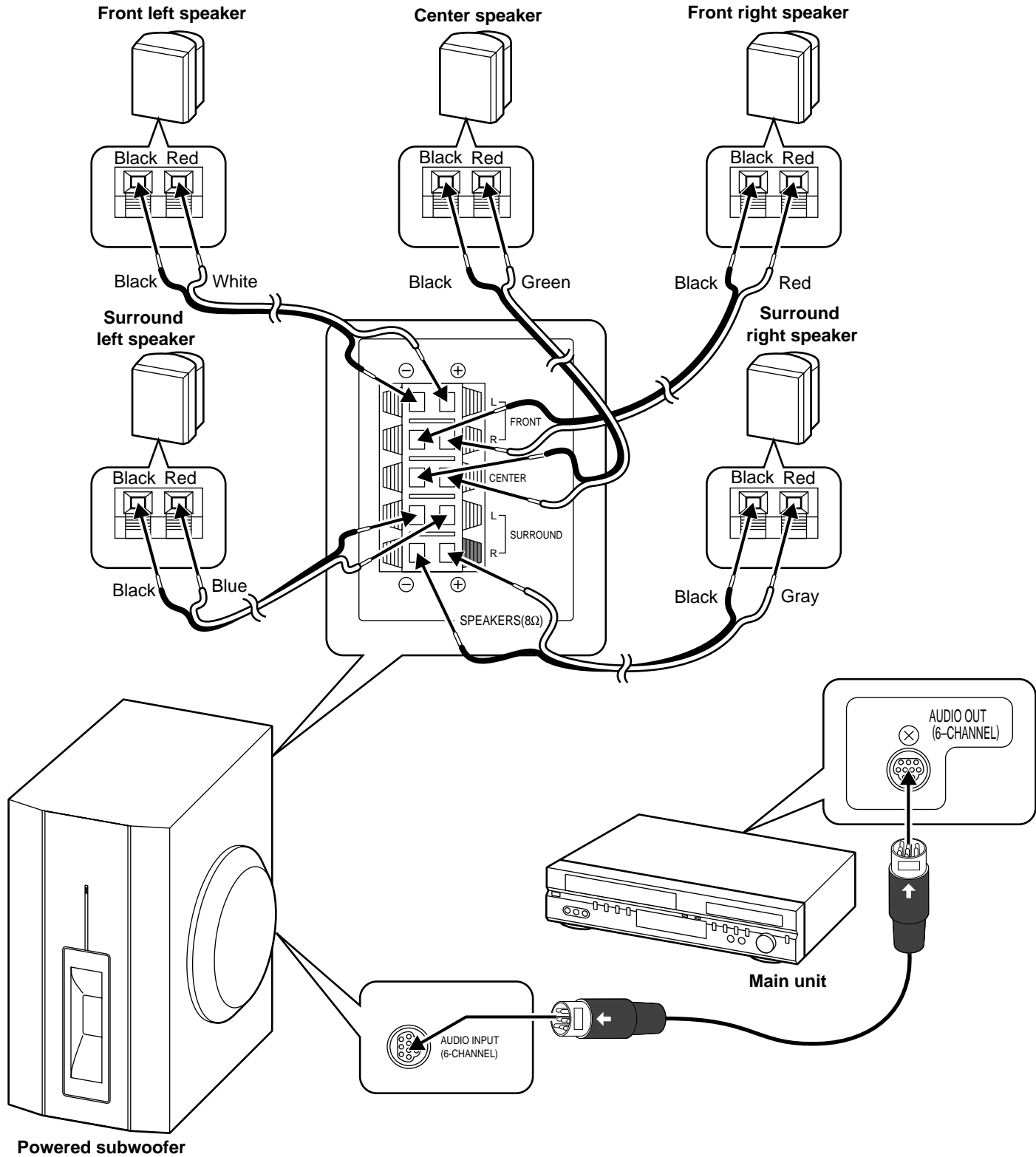



Speaker Placement

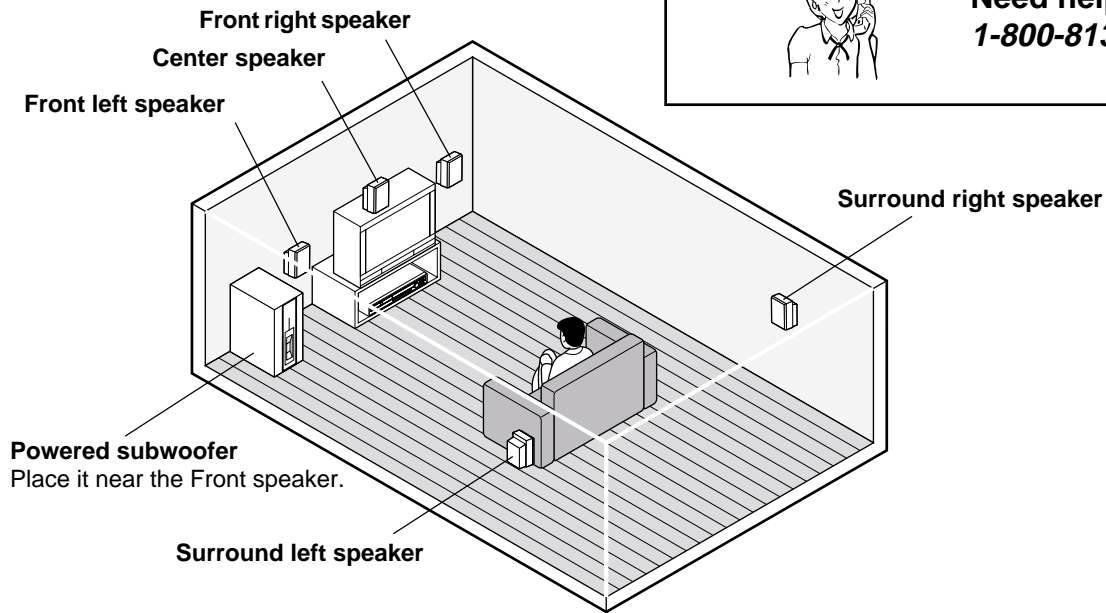

The supplied speakers have built-in magnetic stray field compensation. They may be placed close to a TV without affecting the color purity.

The five speakers are all the same and can be used for Front left, Center, Front right, Surround left, and Surround right speakers.

The front, center, and surround speakers should be placed at approximately the same distance from the listening position.

Place the front left and right speakers either side of the TV.

Place the center speaker directly above the TV.

Place the surround speakers either sides of the listening position, or slightly to the rear, approximately 2 feet ~ 3 feet 3 inches (60 cm ~ 1 meter) higher than ear level.

The powered subwoofer can be placed near the front speaker and not too far from the TV.

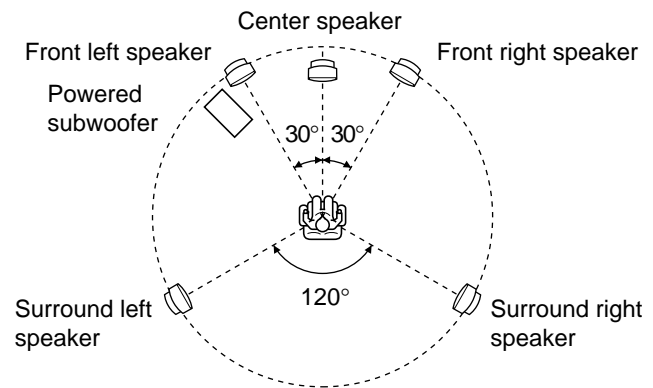

Notes:

- The angles in the diagram are approximate.
- Please see to "Changing the Delay Time" on page E23.
- Set the TV's built-in speaker volume to minimum.

Example: To hang the speaker on a wall

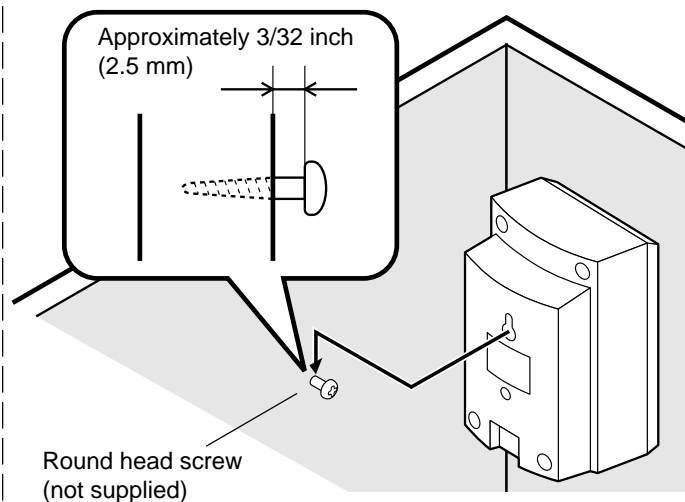

Note: Be careful of dropping the speaker system, it might cause damage or serious injuries.

Example: To mount the speaker with a stand

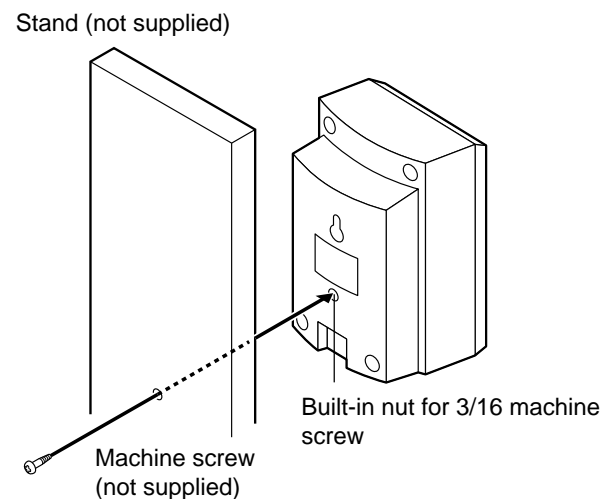



AM/FM Antenna Connections

FM antenna

The FM indoor antenna lead wire is sufficient to receive most local FM signals.

1. Unwind the antenna lead wire.
2. Twist the end of the wire and pull it off.

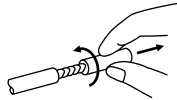

3. Connect it to the rear FM 75 Ω terminal. See the illustration on the right.
4. Extend it as straight as possible and, while listening to the sound from the system, secure it in a position where the best FM reception is found.

In fringe areas, or where reception is distorted or noisy, an FM outdoor antenna (not supplied) should be connected instead of the FM indoor antenna lead wire. The terminals will accept 75-ohm coaxial cable.

AM antenna

The AM loop antenna is sufficient to receive most local AM broadcasts. Assemble the loop antenna.

Unwind the antenna wires, then connect them to the AM LOOP terminals. Place the loop antenna in a position which yields the best AM reception, or attach it to a wall or other surface as shown.

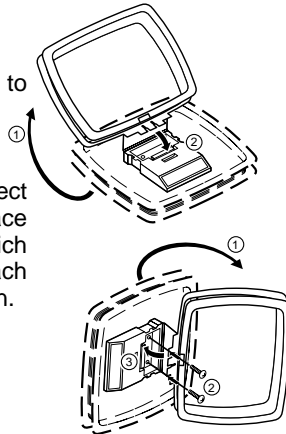

Screws (not supplied)

Note:

To minimize noise...

- Keep the speaker wires, power cord and all other system connection cables away from the loop antenna.
- Do not place the antenna close to a TV or speaker.

Note to CATV system installer:

This reminder is provided to call the CATV system installer's attention to Section 820-40 of the NEC which provides guidelines for proper grounding and, in particular, specifies that the cable ground shall be connected to the grounding system of the building, as close to the point of cable entry as practical.

Power Supply (Main Unit and Powered Subwoofer)

Connect the power cord to a 120V AC 60Hz outlet. This unit is equipped with a polarized plug. If you have difficulty inserting the plug, turn it over and reinsert it. If the unit will not be used for a long time, disconnect the AC plug from the AC outlet.

The powered subwoofer will automatically turn on when the main unit is turned on.

The POWER indicator lights on the powered subwoofer.

Notes:

- Before plugging the power cord into an AC outlet, make sure that all the connections have been made.
- The main unit and powered subwoofer are not disconnected from the AC power unless the power cord is unplugged from the AC outlet.

CAUTION:

When installing an outdoor antenna, follow the installation instructions in "IMPORTANT SAFETY INSTRUCTIONS" on page E2.

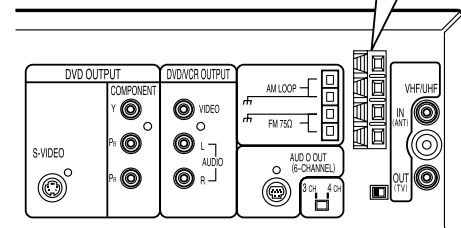
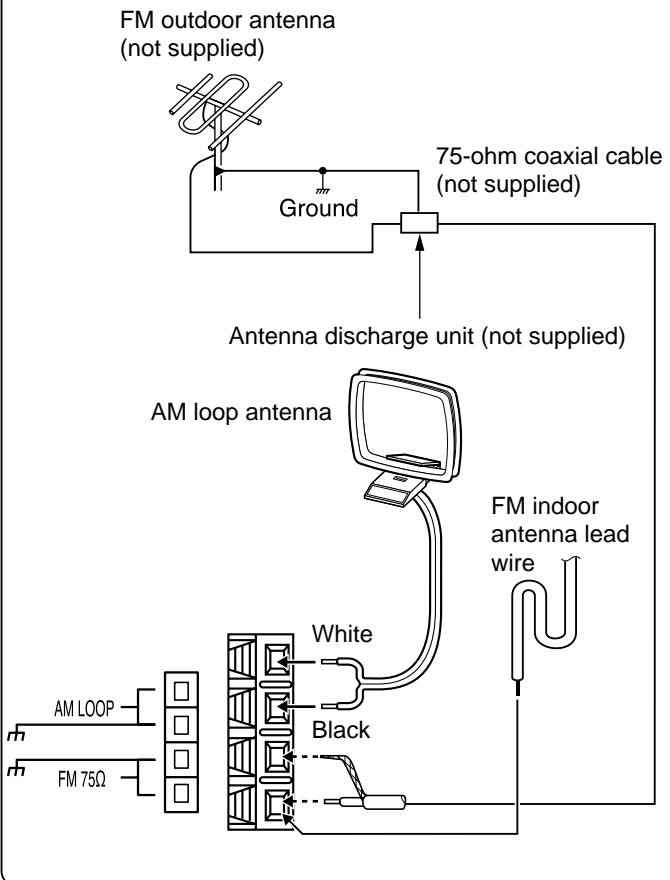

Main unit



**Need help? Call
1-800-813-3435**



ADJUSTING THE CLOCK

Auto Clock Setting

The Auto Clock feature enables the automatic clock setting and updating, and also to set the Time Zone and Daylight Saving Time by receiving XDS (Extended Data Service) information carried on the channel signal.

Preparation:

You must set the antenna connection before the AC cord plug is inserted into the AC outlet.

Auto clock setting

WAIT 30 MINUTES! when the power switch is off, after the connections of the antenna and the power plug. Because the Auto Clock setting feature is activate.

After the clock is set automatically, you may have to set the Time Zone and Daylight Saving Time.

Press [POWER] to turn on the unit after the Auto Clock operation completed.

- When shipped from factory, the AUTO CLOCK option is set to "ON" position.
- If you turn the unit on during Auto Clock setting, the clock is not set.
- With cable box connection, if the Auto Clock Setting is unsuccessful, please select the PBS channel carrying the XDS information, then turn the unit off. After 30 minutes, turn the unit on, and if the clock is not set automatically, set the clock manually. (See page E19.)

Time Zone setting (STANDARD TIME)

In the rare event that you live within broadcast range of two stations in two different time zones, the unit may recognize the wrong station for the AUTO CLOCK set. To correct the situation:

Preparation:

- Turn ON the TV.
- When a TV is connected with an audio/video cable, select the video input mode on the TV.
- When a TV is connected only with an antenna cable, set to the video channel 3 or 4. Then select VCR position with [TV/VCR].
- Press [VCR] to select the VCR mode. (The VCR indicator on the front panel will light.)

1. Press [SETUP/MENU].

The "MENU" screen appears on the TV screen.

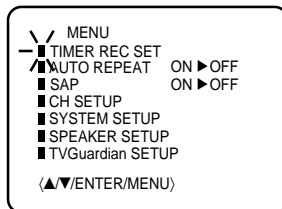

2. Press [▲] or [▼] to select "SYSTEM SETUP", then press [ENTER].

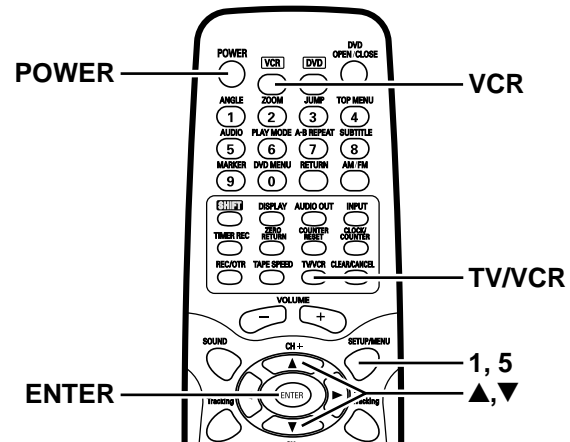
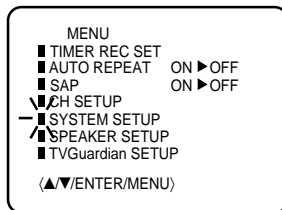

3. Press [▲] or [▼] to select "STANDARD TIME", then press [ENTER].

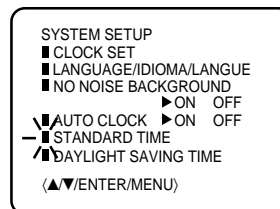

4. Press [▲] or [▼] to select your Time Zone, then press [ENTER].

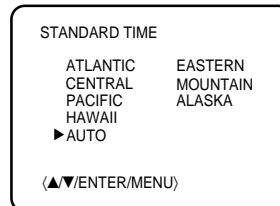

5. Press [SETUP/MENU] until the menu screen is cleared.

Notes:

- After Auto Clock setting, in some case the clock may display the other time zone's. You can correct the clock by selecting your Time Zone setting above.
- When the clock is not set or you set the clock manually, Time Zone setting is not available.



Need help? Call
1-800-813-3435

Daylight saving time setting

You can set the Daylight saving time automatically or manually.

- Repeat the steps 1 ~ 2 on page E17 and press [▲] or [▼] to select "DAYLIGHT SAVING TIME", then press [ENTER].

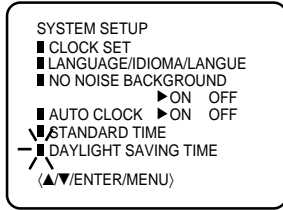

- Press [▲] or [▼] to select one of the options, then press [ENTER].

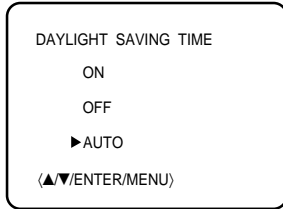

- ON: for manual setting (forward one hour)
 OFF: for manual setting (back one hour)
 AUTO: for automatic setting (read XDS in the signal)

When you want to set the Daylight Saving Time manually, on the first Sunday in April you set to "ON", and on the last Sunday in October you set to "OFF".

Notes:

- When shipped from factory, the "DAYLIGHT SAVING TIME" option is set to "AUTO" position.
- When the clock is not set, Daylight Saving Time setting is not available.
- When there is no Daylight Saving Time in your area, always select "OFF" position in step 2.

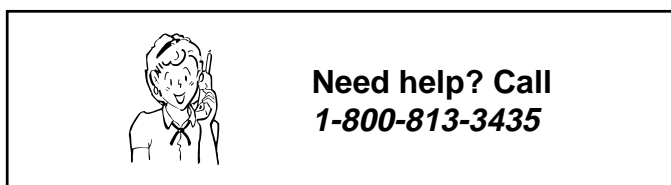
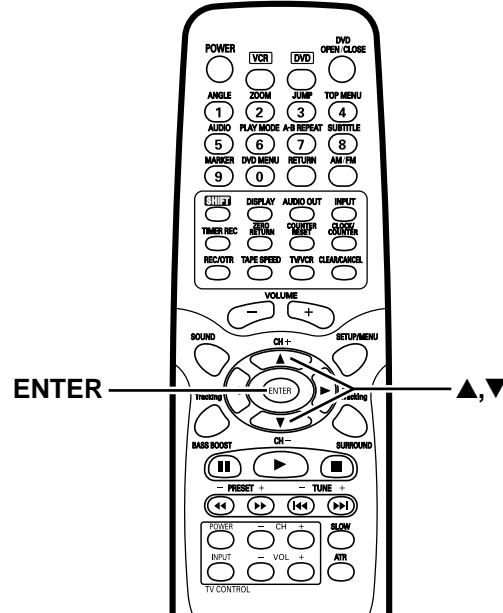



Manual Clock Setting

You must set the date and time for timer recordings.

Preparation:

- Turn ON the TV and set to the video input mode.
- Press [VCR] to select the VCR mode. (The VCR indicator on the front panel will light.)

Example: Setting the clock to "8:30 AM" March, 26 (WED), 2003.

1. Press [SETUP/MENU].
The "MENU" screen appears on the TV screen.

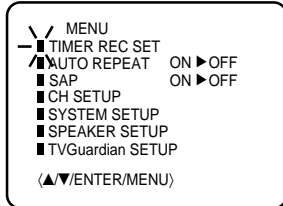

2. Press [▲] or [▼] to select "SYSTEM SETUP", then press [ENTER].

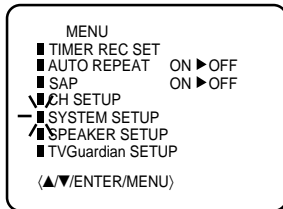

3. Press [▲] or [▼] to select "CLOCK SET", then press [ENTER].

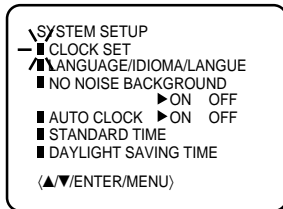

4. Press [▲] or [▼] to set the month, then press [ENTER].

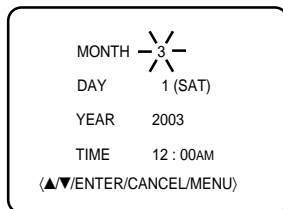

5. Set the day, year and time as in step 4.

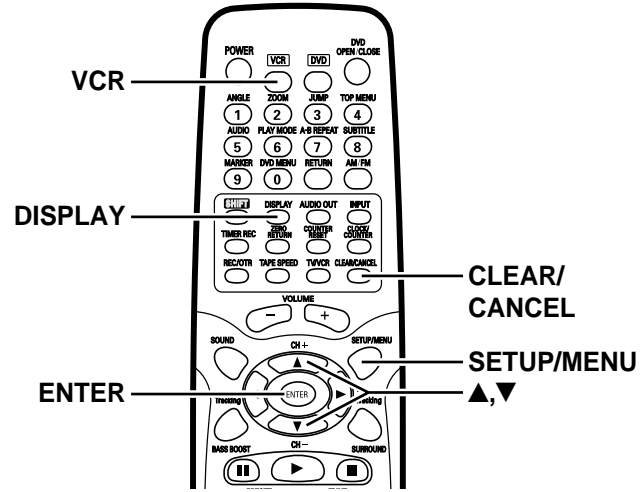
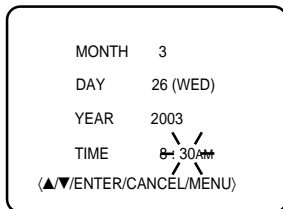

6. After setting the clock, the screen turns gray for a moment then the time and date display on the TV screen for approximately 4 seconds.
Date and time starts automatically.

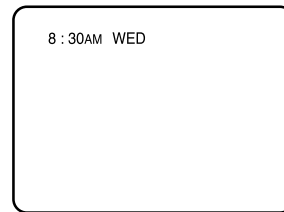

Notes:

- To make corrections any time during the process, press [CLEAR/CANCEL] repeatedly until the item you want to change blinks, then press [▲] or [▼].
- After setting the clock, if you want to confirm the time and date, press [VCR] to select the VCR mode and press [DISPLAY]. The time and date will appear on the TV screen (see page E32).
- If a power failure occurs or the AC power cord is disconnected, reset the clock again.



**Need help? Call
1-800-813-3435**

BEFORE OPERATION

Common Operation

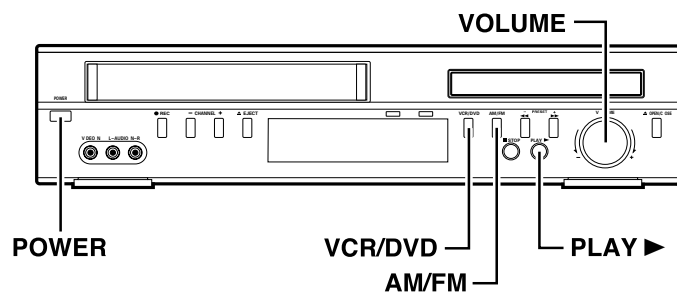

Turning the power on and off

Press [POWER] to turn the power on.
 (After connecting the power cord, when you press [POWER] for the first time, the volume-reset feature automatically sets the initial volume level.)
 When the power cord is connected to the AC outlet, the unit will respond to commands from the remote control.

To turn the power off, press [POWER] again.

Selecting the source

Remote control operation

Press [VCR] to select the "VCR" function.
 Press [DVD] to select the "DVD" function.
 Press [AM/FM] to select the "Tuner" function.
 Press [INPUT] repeatedly in the "VCR" function to select the external source connected to AUDIO/VIDEO IN jacks on the front panel or original source.

Notes:

- When the source is selected the "DVD" or "Tuner" function, you cannot use [INPUT] button.
- When the source selection is changed to the "Tuner" function, disc and tape playback automatically stops.

Front panel operation

Press [VCR/DVD] repeatedly to select the "VCR" or "DVD" function.
 Press [AM/FM] to select the "Tuner" function.

Adjusting the volume

Rotate [VOLUME] on the front panel (or press [VOLUME] + or - on the remote control). The volume level appears on the FL display (Vol 0 ~ Vol 40).

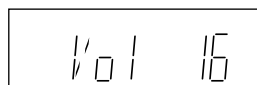

Note:

Set the TV's built-in speaker volume to minimum.

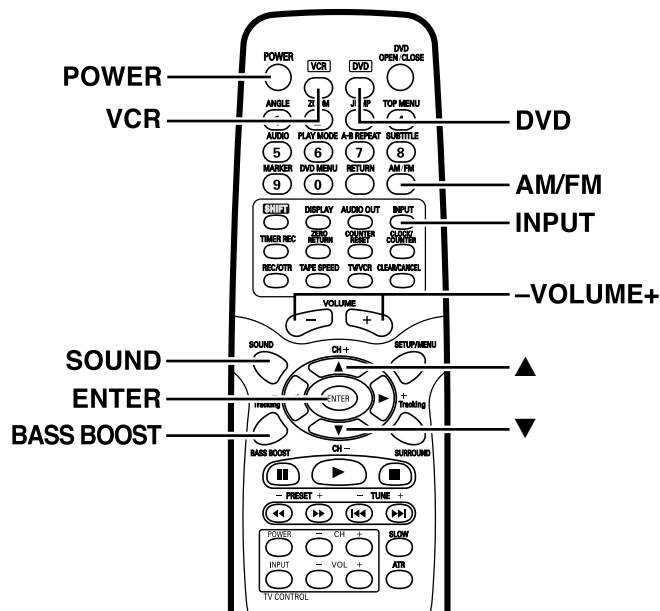

Adjusting the bass, treble and speaker level

1. Press [SOUND].
 "BA" appears on the FL display.



2. Press [ENTER] repeatedly to select the desired sound mode. Each time [ENTER] is pressed, the sound mode changes as follows:
 BA (Bass) → TR (Treble) → FL (Front left speaker) → C (Center speaker) → FR (Front right speaker) → SR (Surround right speaker) → SL (Surround left speaker) → SU (Subwoofer) → BA (Bass)...
3. Press [▲] or [▼] to adjust the sound level.
 BA/TR: "+5" ~ "-5".
 FL/FR: "0" ~ "-10".
 C/SR/SL/SU: "+10" ~ "-10".
4. Repeat steps 2 ~ 3 for another sound mode.

- You can also use the menu screen to adjust the speaker level. See "Adjusting the Speaker and Subwoofer Level" on page E22.

Bass boost system

Press [BASS BOOST].
 "BA" appears on the FL display.



Press the button repeatedly to select the bass boost effect ON or OFF.
 BA ON → BA OFF → BA ON...



Selecting Surround Mode

Press [SURROUND] to select the surround mode.
"AUTO" appears on the FL display.

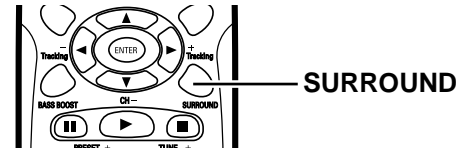

Each time the button is pressed, the surround mode changes as follows:

AUTO → Surr (Surround) → HALL → LIVE → 2ch → AUTO ...

Function	FL display	Description
DVD	AUTO	The unit selects the surround mode automatically depending on the disc. Dolby Digital (not encoded with Dolby Surround Sound) "D D" appears on the FL display. Dolby Digital is a discrete 5.1 channel surround system, developed for cinema use. But, not all Dolby Digital sources are recorded with 6 channel. Some sources marked Dolby Digital may be recorded in Dolby Surround, a 2 channel system. Dolby Digital (encoded with Dolby Surround Sound) "D D" and "D D PL" appear on the FL display. The surround mode is set to Dolby Pro Logic mode. Dolby Pro Logic is a decoding system that was developed to enhance the soundtracks of theatrical motion pictures with Dolby Surround. All speakers sound, but the surround left and right speakers are monophonic sound. Other (PCM, CD, MP3, etc.) The surround mode is set to 2.1 channel (Front left and right speakers, and Subwoofer).
	Surr	All discs are set to Dolby Pro Logic mode.
	HALL	When playing a program source which is not encoded with Dolby sound.
	LIVE	When playing a program source which is not encoded with Dolby sound.
	2ch	The surround mode is set to 2.1 channel (Front left and right speakers, and Subwoofer).
VCR AM/FM	AUTO	It is set to 2.1 channel (Front left and right speakers, and Subwoofer).
	Surr	All sources are set to Dolby Pro Logic mode.
	HALL	When playing a program source which is not encoded with Dolby sound.
	LIVE	When playing a program source which is not encoded with Dolby sound.
	2ch	It is set to 2.1 channel (Front left and right speakers, and Subwoofer).

Notes:

- DVD video disc with DTS may not work correctly. You can see the picture on the TV screen, but there is no sound.
- There is no Dolby Surround effect when monaural program material is used.
- When receiving weak FM broadcasts, set it to "2ch". The sound quality may improve.
- To obtain sound from all 5 speakers, play any DVD disc encoded with DOLBY 5.1, or press the SURROUND button repeatedly to select one of the surround modes besides AUTO during playback of Audio CD, MP3 CD, WMA CD or VHS recorded material. Otherwise, unit automatically defaults to 2ch-mode that plays front left and right speaker.



**Need help? Call
1-800-813-3435**



Adjusting the Speaker Volume Balance

This unit is set to the standard level before shipping from the factory. You may not need adjustment.

But, depending on the size of the room and the placement of the speakers, you may need a fine adjustment.

In this case, follow the steps below. Please use the remote control at the listening point.

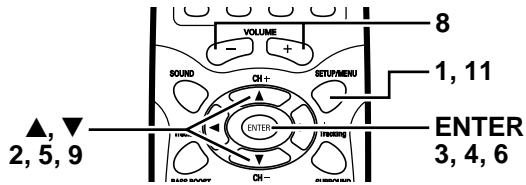

1. Press [SETUP/MENU].
When the unit is in DVD mode and in the Stop mode or disc is not inserted, press [SETUP/MENU] twice.
The "MENU" screen appears on the TV screen.

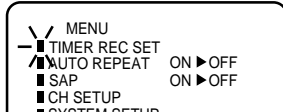

2. Press [▲] or [▼] to select "SPEAKER SETUP".

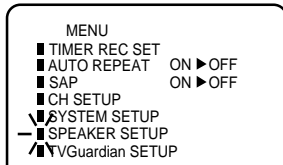

3. Press [ENTER].
The "SPEAKER SETUP" screen appears on the TV screen.

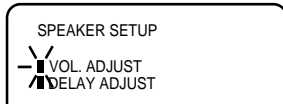

4. Press [ENTER].
The "VOL. ADJUST" screen appears on the TV screen.

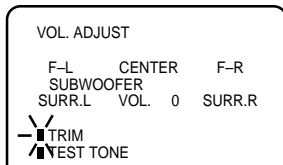

5. Press [▲] or [▼] to select "TEST TONE".
6. Press [ENTER].
7. The test tone will be heard from each speaker for 2 seconds in the following order.

TV screen	Speaker
F-L	Front left Speaker
CENTER	Center Speaker
F-R	Front right Speaker
SURR.R	Surround right Speaker
SURR.L	Surround left Speaker

8. Press [VOLUME] + or - until the test tone is at a comfortable level.
9. If the test tone level is not the same from each speaker, press [▲] or [▼] to adjust it while the speaker is activating.
F-L/F-R: "0" ~ "-10"
CENTER/SURR.R/SURR.L: "+10" ~ "-10"
10. Repeat steps 8 ~ 9 for other settings.
11. Press [SETUP/MENU] until the menu screen is cleared.

Adjusting the Speaker and Subwoofer Level

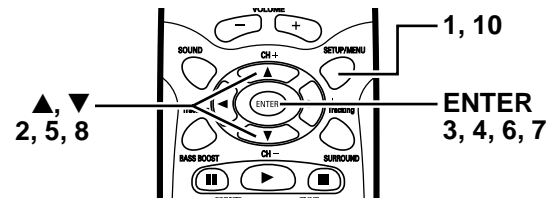

1. Press [SETUP/MENU].
When the unit is in DVD mode and in the stop mode or disc is not inserted, press [SETUP/MENU] twice.
The "MENU" screen appears on the TV screen.

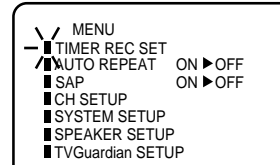

2. Press [▲] or [▼] to select "SPEAKER SETUP".

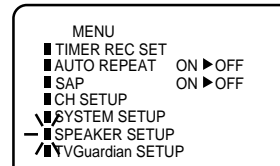

3. Press [ENTER].
The "SPEAKER SETUP" screen appears on the TV screen.

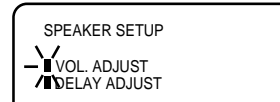

4. Press [ENTER].
The "VOL. ADJUST" screen appears on the TV screen.

5. Press [▲] or [▼] to select "TRIM".

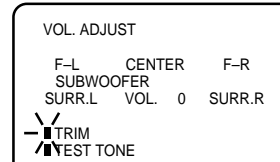

6. Press [ENTER].

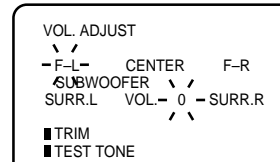

7. Press [ENTER] repeatedly to select the desired speaker.
Each time the button is pressed, the selected speaker and tone level flash.
8. Press [▲] or [▼] to adjust the level as desired.
F-L/F-R: "0" ~ "-10"
CENTER/SURR.R/SURR.L/SUBWOOFER: "+10" ~ "-10"
Note: No test tone.
9. Repeat steps 7 ~ 8 for other settings.
10. Press [SETUP/MENU] until the menu screen is cleared.

Note:
If no adjustment are made, the original display returns after approximately 60 seconds.



Changing the Delay Time

The sound from speakers can reach the listening position at different times depending the speaker placements. You can allow for this difference by changing the delay time of the center and surround speakers.

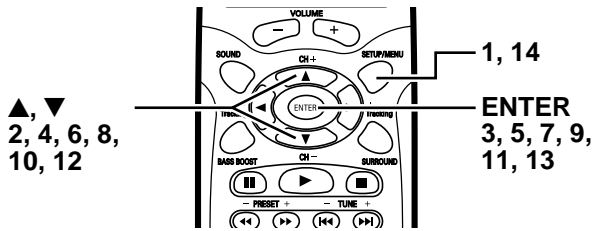

1. Press [SETUP/MENU] once or twice in the stop mode or disc is not inserted.
The "MENU" screen appears on the TV screen.

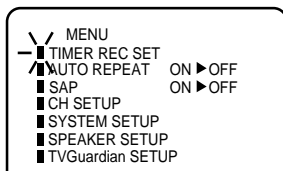

2. Press [▲] or [▼] to select "SPEAKER SETUP".
3. Press [ENTER].
The "SPEAKER SETUP" screen appears on the TV screen.

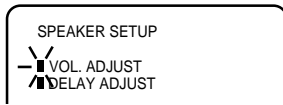

4. Press [▲] or [▼] to select "DELAY ADJUST".
5. Press [ENTER].
The "DELAY ADJUST" screen appears on the TV screen.

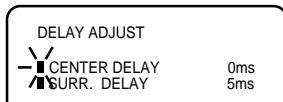

6. Press [▲] or [▼] to select "CENTER DELAY".
7. Press [ENTER].

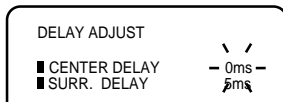

8. Press [▲] or [▼] to select the center speaker delay time.
("0ms", "1ms", "2ms", "3ms", "4ms" and "5ms")

Center speaker delay time

If $D1 \leq D2$, set the delay time to "0ms".

If $D1 > D2$, set the delay time as follows:

Difference between D1 and D2	Delay time
1 foot (Approx. 30.5cm)	1ms
2 feet (Approx. 61cm)	2ms
3 feet (Approx. 91.5cm)	3ms
4 feet (Approx. 122cm)	4ms
5 feet (Approx. 152.5cm)	5ms

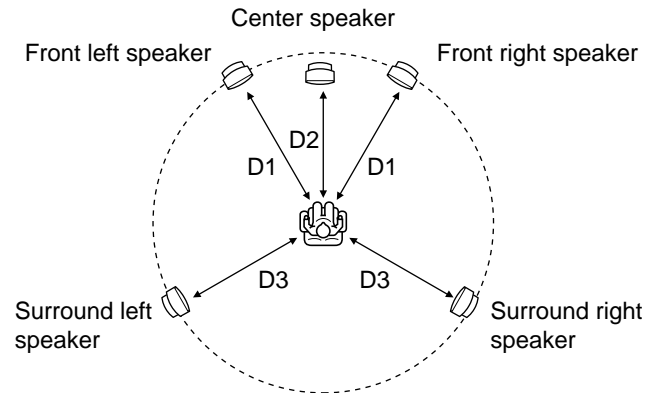

D1: The distance from the front speaker
D2: The distance from the center speaker
D3: The distance from the surround speaker

9. Press [ENTER].
"CENTER DELAY" and the selected delay time remain.

10. Press [▼] to select "SURRE. DELAY".

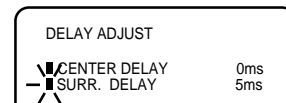

11. Press [ENTER].

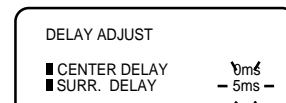

12. Press [▲] or [▼] to select the surround speaker delay time.
("0ms", "5ms", "10ms" and "15ms")

Surround speaker delay time

If $D1 \leq D3$, set the delay time to "0ms".

If $D1 > D3$, set the delay time as follows:

Difference between D1 and D3	Delay time
5 feet (Approx. 152.5cm)	5ms
10 feet (Approx. 305cm)	10ms
15 feet (Approx. 457.5cm)	15ms

13. Press [ENTER].
"SURRE. DELAY" and the selected delay time remain.

14. Press [SETUP/MENU] until the menu screen is cleared.

Note:

If no adjustments are made, the original display returns after approximately 60 seconds.

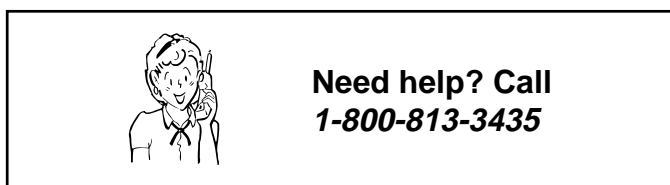



Setting the Video Channel

To view playback of a recorded tape or DVD disc, or to watch a program selected by the VCR's channel selector, the TV must be set to channel 3 or 4 (video channel).

When a TV is connected with the 75 ohm coaxial cable only.

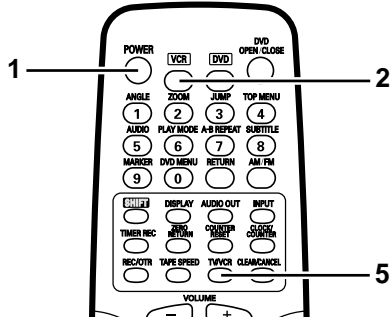

1. Press [POWER] to turn on the unit.
2. Press [VCR] to select the VCR mode.
The VCR indicator on the front panel will light.
3. Set the channel selector switch on the rear panel to 3 CH or 4 CH.

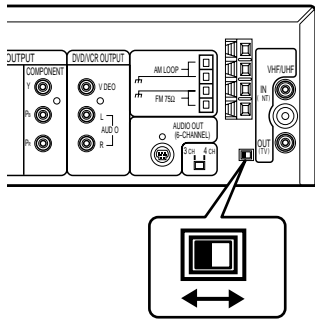

4. Turn ON the TV and set to channel 3 or 4 to correspond with the channel selected in step 3.
5. Press [TV/VCR] to select the VCR position.
"VCR" will appear on the FL display.
6. Select any channel to receive a TV station in your area.
The channel number will appear on the screen for approximately 4 seconds.

For a push-button TV tuner

If channel 3 or 4 corresponding to the video channel cannot be tuned on your TV, proceed as follows: set the channel selector switch on the main unit's rear panel and the TV to 3 CH or 4 CH, play back a prerecorded tape and tune the TV to receive a sharp color picture from the video cassette recorder. Refer to your TV owner's manual for details.

Setting the Language

You can choose from three different languages (English, Spanish, and French) for the on-screen displays.

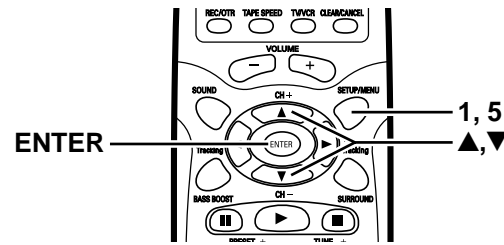

1. Press [SETUP/MENU].
If you use the unit for the first time and press [SETUP/MENU], instead of the main menu screen below the "SYSTEM SETUP" menu screen in step 3 may appear.

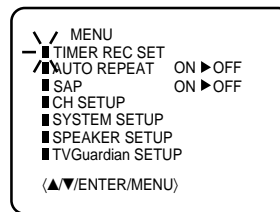

2. Press [▲] or [▼] to select "SYSTEM SETUP", then press [ENTER].
3. Press [▲] or [▼] to select "LANGUAGE/IDIOMA/LANGUE", then press [ENTER].

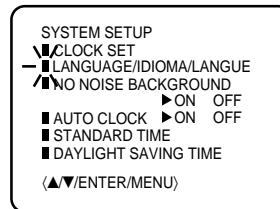

4. Press [▲] or [▼] to select the desired language: English (ENGLISH), Spanish (ESPAÑOL) or French (FRANCAIS), then press [ENTER].

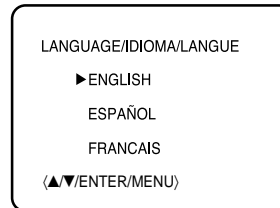

5. Press [SETUP/MENU] until the menu screen is cleared.

Notes:

- Both the VCR and the DVD have their own menu (see page E56).
- If no buttons are pressed for more than 60 seconds, the MENU screen will return to normal TV-operation automatically.

VCR Tuner Setting

The built-in VCR is equipped with a channel memory feature which allows channels to skip up or down to the next channel set into memory, skipping over unwanted channels. Before selecting channels, they must be programmed into the VCR's memory. In addition to normal VHF and UHF channels, this VCR can receive up to 125 Cable TV channels. To use this VCR with an antenna, set the TV/CATV menu option to the TV mode. When shipped from the factory, this menu option is in the CATV mode.

Preparation:

- Turn ON the TV and set to the video input mode.
- Press [VCR] to select the VCR mode. (The VCR indicator on the front panel will light.)

Note:

You can't select "CH SETUP" if you set the channel to "L".

TV/CATV selection

1. Press [SETUP/MENU].
The "MENU" screen appears on the TV screen.

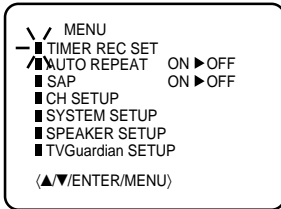

2. Press [▲] or [▼] to select "CH SETUP", then press [ENTER].

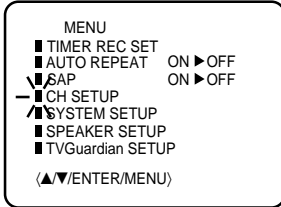

3. Press [▲] or [▼] to select "TV/CATV".

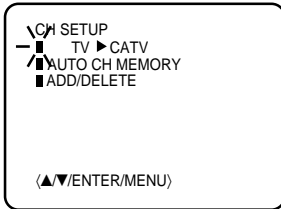

4. Press [ENTER] to select the "TV" or "CATV".

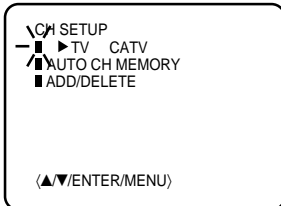

- The arrow indicates the selected mode.
TV: VHF/UHF channels
CATV: CABLE TV channels

5. Press [SETUP/MENU] until the menu screen is cleared.

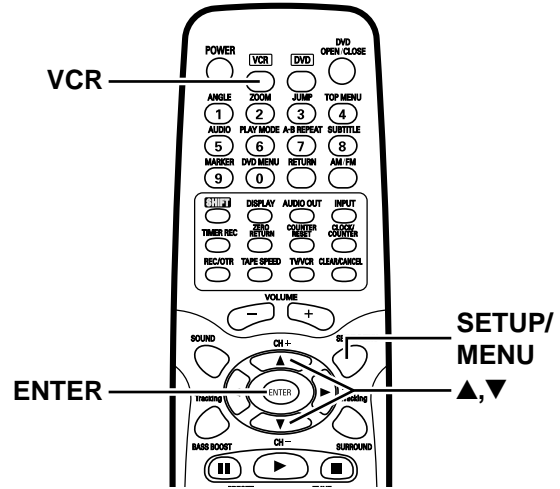

Setting channels automatically

The VCR can receive a maximum of 125 channels in CATV mode, 69 channels in TV mode by presetting the channels into memory.

1. Repeat left steps 1 ~ 2 and press [▲] or [▼] to select "AUTO CH MEMORY".

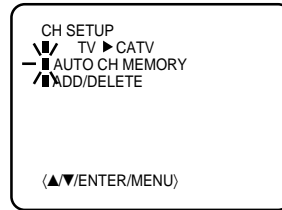

2. Press [ENTER].
The auto tuning will start. The channel display will count up and when finished, the "CH SETUP" menu will reappear.
3. Press [SETUP/MENU] until the menu screen is cleared.



**Need help? Call
1-800-813-3435**

To ADD/DELETE Channels

You can add the channels you want or delete the channels you do not want manually.

Preparation:

- Turn ON the TV and set to the video input mode.
- Press [VCR] to select the VCR mode. (The VCR indicator on the front panel will light.)

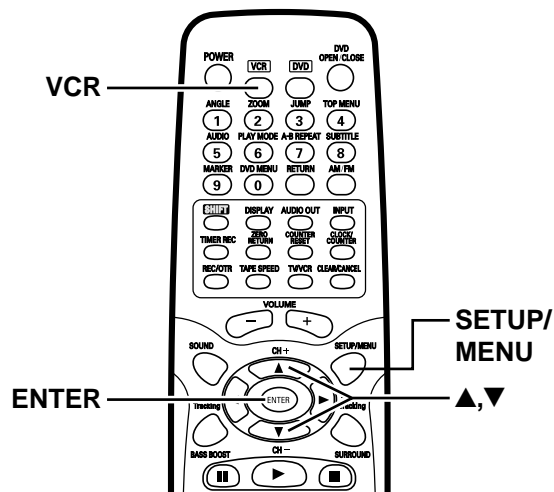

1. Repeat the steps 1 ~ 2 in "TV/CATV selection" on page E25. Then press [▲] or [▼] to select "ADD/DELETE" and press [ENTER].

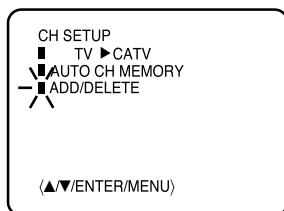

2. Press the number button(s), [▲] or [▼] to select a channel number you want to add or delete.

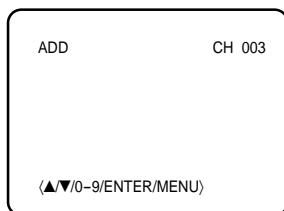

3. **To add channels**
Press [ENTER] until "ADD" appears on the screen to set to add the unmemorized channel.
To delete channels
Press [ENTER] until "DELETE" appears on the screen to set to delete the channel from memory.
The channel number will blink.
4. Repeat steps 2 ~ 3 to add or delete other channel.
5. Press [SETUP/MENU] until the menu screen is cleared.

Noise Elimination

When you don't want to receive a weak signal broadcast, the Blue back screen can be obtained by selecting the NO NOISE BACKGROUND "ON".

1. Press [SETUP/MENU].
The "MENU" screen appears on the TV screen.

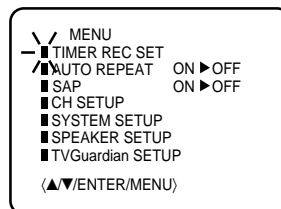

2. Press [▲] or [▼] to select "SYSTEM SETUP", then press [ENTER].

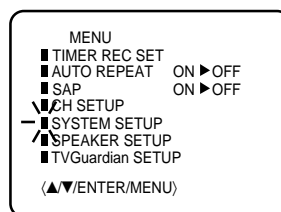

3. Press [▲] or [▼] to select "NO NOISE BACKGROUND".

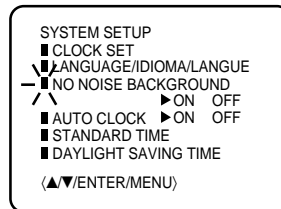

4. Press [ENTER] to select the "ON" or "OFF" position.
5. Press [SETUP/MENU] until the menu screen is cleared.

Note:
When shipped from factory, the "NO NOISE BACKGROUND" option is set to the "ON" position.

VIDEO CASSETTE TAPE PLAYBACK

Loading and Unloading a Cassette Tape

Use only video cassette tapes marked **VHS** and **SVHS**.

Loading

Push the center of the tape until it is automatically inserted.

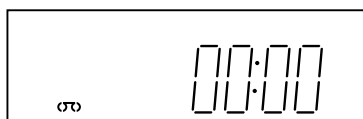

Insert the cassette tape with its labeled side facing up and the erase prevention tab positioned at your left. An inverted cassette tape cannot be inserted.

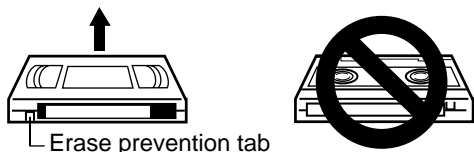

Automatic power ON

When you insert a cassette tape, the unit will turn ON automatically.

Automatic playback

When loading a cassette tape without an erase prevention tab, playback will start automatically.

Unloading

1. Press [▲ EJECT] on the unit.

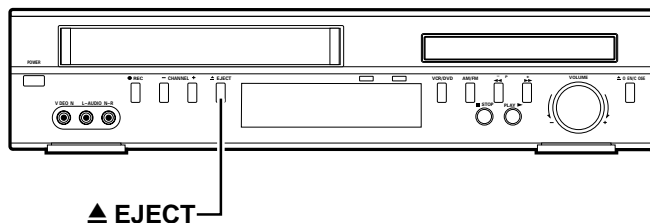

2. Remove the cassette tape.

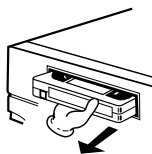

Automatic tape eject

The built-in VCR will automatically rewind the tape when the tape has ended. And when the tape is rewinded to its beginning, the cassette tape will be ejected automatically.

To prevent accidental erasure

Remove the erase prevention tab with a screwdriver.

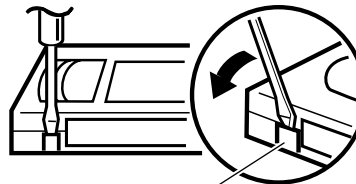

Erase prevention tab

To record again

Cover the hole with a piece of adhesive tape.



Adhesive tape

Tape speed and maximum recording time

Tape Speed	Video Cassette Tape				
	T-160	T-120	T-90	T-60	T-30
SP (Standard Play)	2-2/3 hours	2 hours	1-1/2 hours	1 hour	30 minutes
SLP (Super Long Play)	8 hours	6 hours	4-1/2 hours	3 hours	1-1/2 hours



Basic Playback

Preparation:

- Turn ON the TV and set to the video input mode.
- Press [VCR] to select the VCR mode. (The VCR indicator on the front panel will light.)

1. Load a prerecorded tape. (When loading a cassette tape without the erase prevention tab, playback will start automatically.)

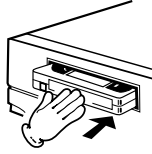

2. Press [▶].
 - Playback will start.
 - "▶" will appear on the TV screen for approximately 4 seconds.

To stop playback

Press [■].

The tape will stop but remain fully loaded and ready to play. "■" will appear on the TV screen for approximately 4 seconds.

To rewind the tape or forward it rapidly

1. Press [■] to stop the playback or recording.
2. To rewind the tape, press [◀◀].
 - "◀◀" will appear on the TV screen for approximately 4 seconds.
 To forward the tape, press [▶▶].
 - "▶▶" will appear on the TV screen for approximately 4 seconds.
3. To stop the tape-winding, press [■]. To switch to playback directly (without STOP), press [▶].

Forward/Reverse picture search mode

When the tape is being winded, you can switch to picture search mode (see next page). To do this, press [◀◀] or [▶▶] and hold it down. The unit will resume the tape winding as soon as the button is released.

Notes:

- This VCR selects the playback tape speed SP, LP or SLP automatically.
- The Cassette tape and DVD disc can be played back simultaneously. If you press [VCR] or [DVD], the tape playback and DVD playback alternate with each other on the screen.

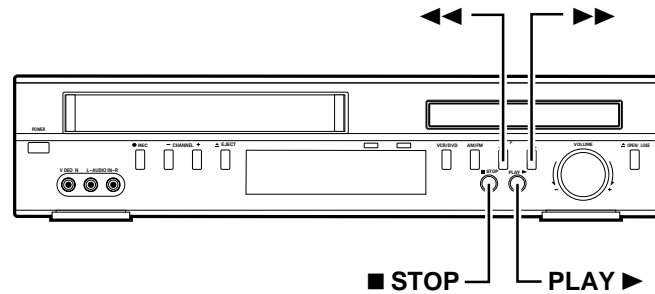
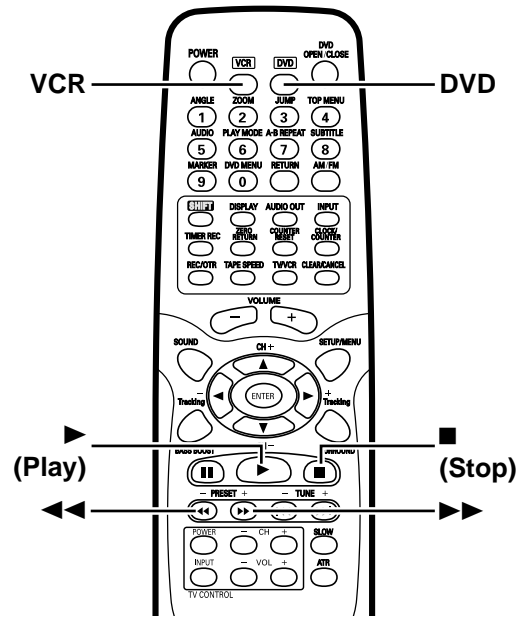

**Need help? Call
1-800-813-3435**



Special Playback

Picture Search

Reverse picture search function:

Press [◀◀] x 1 or x 2 during the playback.

Forward picture search function:

Press [▶▶] x 1 or x 2 during the playback.

To return to playback: Press [▶].

SPEED SEARCH TIMES

TAPE SPEED	PICTURE SEARCH SPEED	
	PRESS ONCE	PRESS TWICE
SP (Standard Play)	3 X	5 X
LP (Long Play)	7 X	9 X
SLP (Super Long Play)	9 X	15 X

Still Picture

Press [⏏] during playback.

To resume normal playback: Press [▶] or [⏏].

Slow Motion

Press [SLOW] during playback.

To return to playback: Press [▶] or [SLOW].

Slow tracking and vertical lock adjustment:

If noise bars appear in the picture during slow motion, press [Tracking] +/- to reduce the noise bars.

If the still picture jitters excessively, press [Tracking] +/- to stabilize the still picture.

Frame by Frame picture

1. Press [⏏] during playback.

2. Press [SLOW] one by one: The picture advances frame by frame.

3. To return to playback: Press [▶] or [⏏].

Adjusting tracking condition

Automatic tracking adjustment:

Whenever you insert a tape and start playback, automatic tracking starts working and continuously analyzes the signal to enable optimum picture quality during playback.

Manual tracking adjustment:

If automatic tracking cannot eliminate noises well during playback, press [Tracking] +/- to eliminate the noises. "MANUAL TR." will appear. Press it briefly for a fine adjustment, or press and hold for a coarse adjustment.

- Press [ATR] to reactivate automatic tracking again. "AUTO TR." will appear.

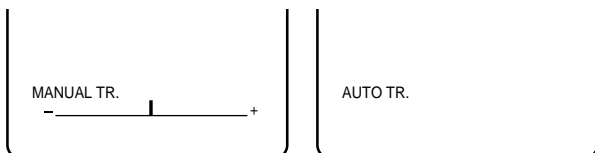

Notes:

- The audio output is muted during SPEED SEARCH, STILL, FRAME ADVANCE and SLOW MOTION.
- During picture search mode there will be noise bars which are caused by the system.
- The Special Playback will automatically change to playback after approx. 5 minutes to protect the video tape against excessive wear.

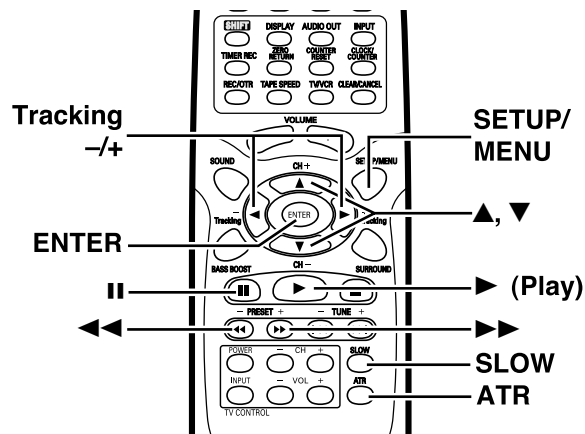

Repeat playback

The entire video tape will be played until its end. The tape will then automatically rewind to the beginning and the playback will be repeated.

- Press [SETUP/MENU].

The "MENU" screen appears on the TV screen.

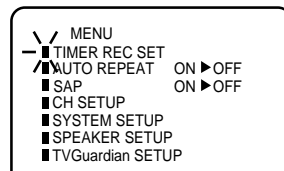

- Press [▲] or [▼] to select "AUTO REPEAT".

- Press [ENTER] to select "ON" or "OFF".

- If "ON" is selected, the playback will be repeated endlessly.

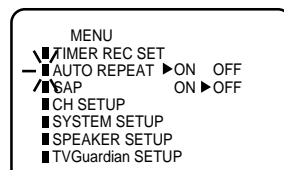

- Press [SETUP/MENU] until the menu screen is cleared.

- If you press [DISPLAY], "⏏" will appear on the TV screen.

- To start the playback, press [▶].

The playback will be repeated endlessly.

To cancel repeat mode:

Follow the above steps 1 ~ 2, then press [ENTER] to select the "OFF" position. Press [SETUP/MENU] to return to the TV.

SQPB (S-VHS Quasi Playback)

You can play back video cassette tapes recorded in the S-VHS system.

However, the picture will not have the high resolution of S-VHS system.

Note:

You cannot record S-VHS video format with this VCR.

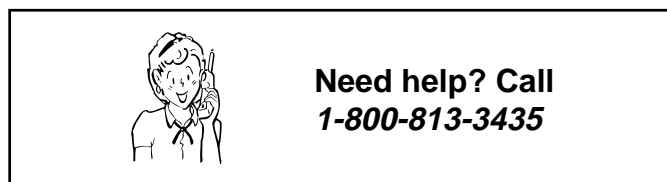



ZERO RETURN Function

This function makes tape-rewinding stop at the counter 00:00:00 position automatically.

Preparation:

- Turn ON the TV and set it to the video input mode.
- Press [VCR] to select the VCR mode. (The VCR indicator on the front panel will light.)

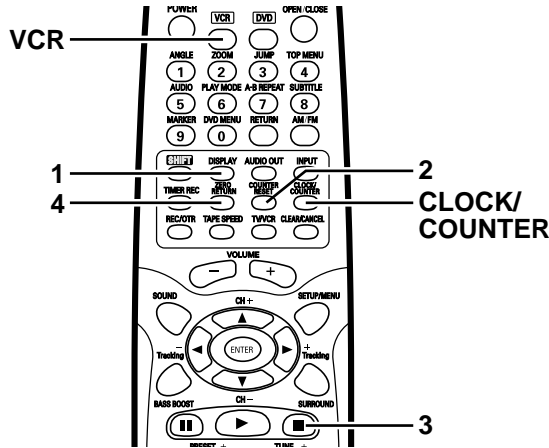

1. Press [DISPLAY].
The counter display shows the tape running time during playback or recording.

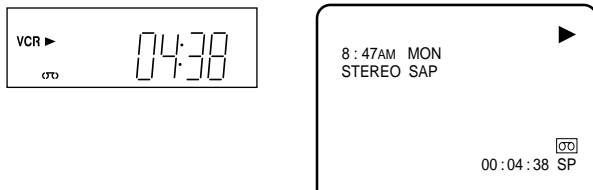

2. Press [COUNTER RESET] at the desired tape position.
The counter display will be reset to the "00:00:00" position (e.g. the beginning of recording).

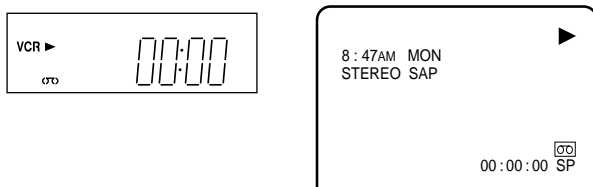

3. Press [■] when playback or recording is finished.
4. Press [ZERO RETURN].
The tape will be rewinded or fast forwarded and automatically stop at the "00:00:00" position.

The CLOCK/COUNTER-button

Press [CLOCK/COUNTER]. The clock and tape counter alternate with each other in the display.

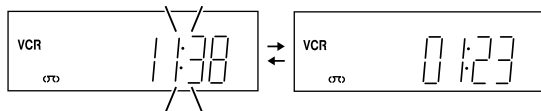

Notes:

- If you rewind the tape beyond "00:00:00", a minus sign ("-") will be displayed in front of the time.
- When you load a tape, the counter will reset to "00:00:00".
- **The counter does not function on nonrecorded (blank) sections of the tape. When you rewind, fast forward or play tapes through blank sections, the counter stops.**

Video Index Search System

This function enables you to locate the beginning of any recording made on the VCR.

Recording an INDEX mark

The Index Search function automatically records an INDEX mark on the tape whenever a recording is initiated.

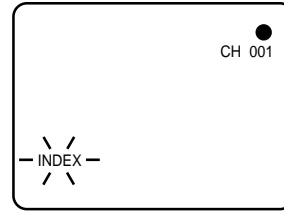

Index Search

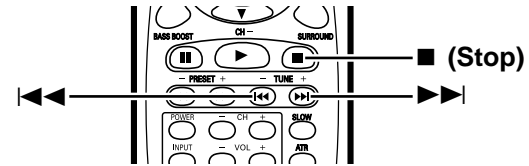

Press [▶▶] or [◀◀] during stop or play mode.

For Succeeding programs: Press [▶▶].

For Preceding programs: Press [◀◀].

(Additional press increases the INDEX NO. up to 9.)

When the [▶▶] or [◀◀] is pressed, the unit starts searching the INDEX NO. selected and finds the portion, then playback starts automatically.

To stop the Index Search, press [■].

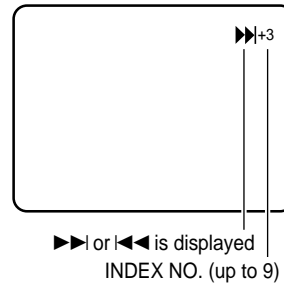

Notes:

- When you record an INDEX mark at the very beginning of the tape, the mark may not be found.
- During INDEX search, the tape may stop and begin to play at a slightly different location.
- INDEX may not function properly with old or worn out video tapes.
- INDEX marks may not be found if it is extremely close to the point where the search began.
- In recording, if you stop recording temporarily, the INDEX mark is not recorded on the tape.

RECORDING

Recording a TV Program

Recording and viewing the same TV program

Preparation:

- Turn ON the TV and set to the video input mode.
- Press [VCR] to select the VCR mode. (The VCR indicator on the front panel will light.)

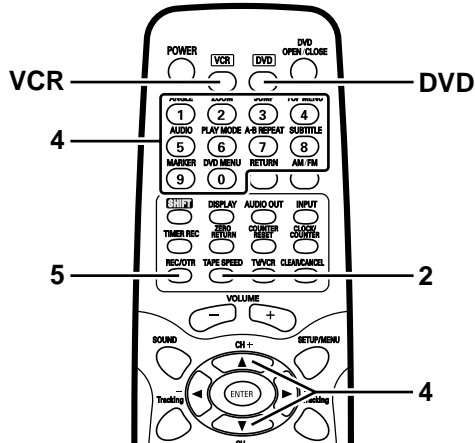

1. Load a cassette tape with the erase prevention tab intact. The unit will automatically turn on.



2. Press [TAPE SPEED] to select the desired tape speed SP or SLP. The tape counter and SP or SLP will appear on the TV screen for approximately 4 seconds.

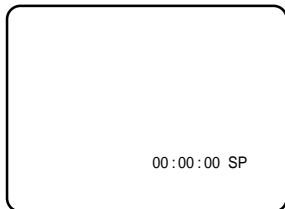

3. Set the "TV/CATV" option to the appropriate position (See "TV/CATV selection" on page E25).
TV: VHF/UHF channels
CATV: CABLE TV channels

4. Press the number buttons [0–9] or [CH] +/- to select the channel to be recorded.

In the TV mode

- 1–9 Press [0] and then [1]–[9] as required.
Example: To select "2", press [0][2].
- 10–69 Press 2 digits in order.
Example: Press [2][2] for "22".

In the CATV mode

- 1–9 Press [0] twice and then [1]–[9] as required.
Example: To select "2", press [0][0][2].
- 10–12 Press [0] first and then the remaining 2 digits in order from left to right.
Example: Press [0][1][2] for "12".
- 13–99 Press 2 digits in order.
Example: Press [2][2] for "22".
- 100–125 Press the 3 digits in order.
Example: Press [1][1][0] for "110".

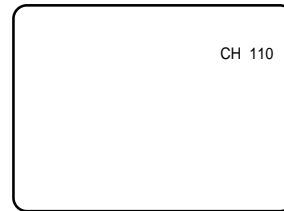

VHF/UHF/CATV CHANNELS

TV	CATV
VHF 2–13	VHF 2–13
UHF 14–69	STD/HRC/IRC 14–36 (A) (W) 37–59 (AA) (WW) 60–85 (AAA) (ZZZ) 86–94 (86) (94) 95–99 (A-5) (A-1) 100–125 (100)(125) 01 (5A)

5. Press [REC/OTR].
"●" will appear on the TV screen for approximately 4 seconds and "REC" will appear on the FL display.

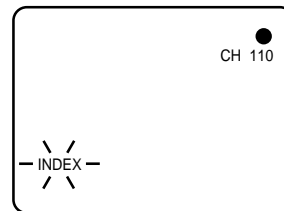

Notes:

- If the erase prevention tab is removed, the tape will eject when [REC/OTR] is pressed for recording.
- If you wish to watch the DVD playback during the normal recording on VCR, press [DVD] to change to DVD mode and perform the DVD playback (see page E39).



To stop recording

Press [■] to stop recording.

"■" will appear on the TV screen for approximately 4 seconds.

To stop recording temporarily

Press [⏸] to avoid recording unwanted material. Press it again to continue the recording.

"●⏸" will appear on the TV screen for approximately 4 seconds.

Notes:

- The pause function will be released after 5 minutes to prevent damage to the tape or the VCR. The VCR will change to the STOP mode.
- You can select a recording channel in the recording pause mode.

Recording one program while watching another

While the VCR is recording, press [TV/VCR] to select the TV position.

"VCR" will go off and recording will continue.

Select the TV channel you want to watch by using the TV channel selector.

Note:

Some CATV hookups do not permit viewing one channel while recording another (see pages E12 and E13).

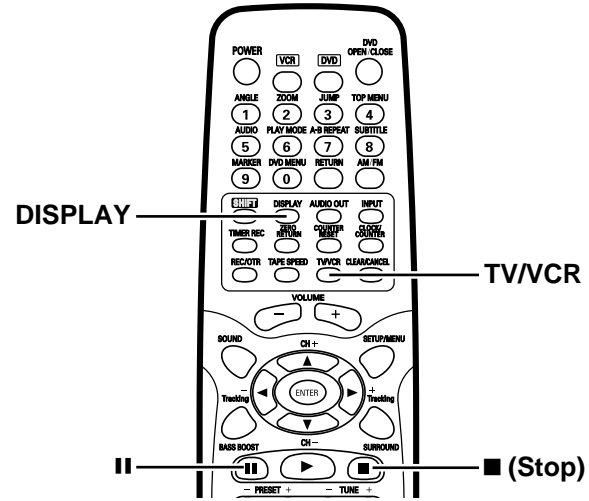

To display VCR operation status

Press [DISPLAY]. The clock, day of the week and more information will be indicated.

While watching TV:

Example:

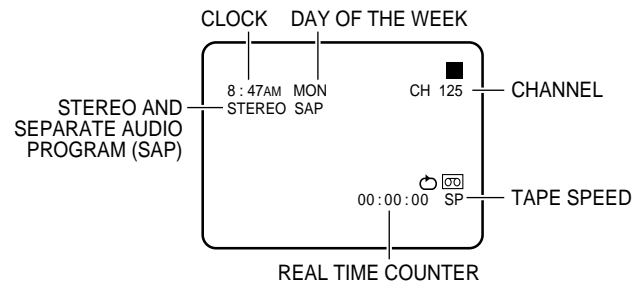

While operating a tape:

Example:

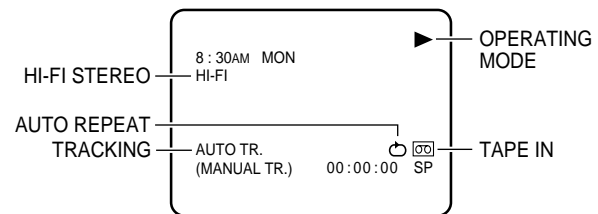

To cancel the display:

Press [DISPLAY] again.

Auto Rewind feature

This VCR will automatically rewind the tape when the tape has ended (except during One-touch Timer Recording and TIMER REC). It will also eject the tape.



**Need help? Call
1-800-813-3435**



One-touch Timer Recording (OTR)

The One-touch Timer Recording feature provides a simple and convenient way to make a timed recording.

Preparation:

- Turn ON the TV and set to the video input mode.
- Press [VCR] to select the VCR mode. (The VCR indicator on the front panel will light.)

Example: One-touch Timer Recording for 30 minutes.

1. Load a cassette tape with the erase prevention tab intact. The unit will automatically turn on.

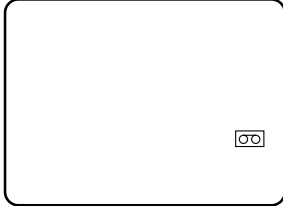

2. Press [TAPE SPEED] to select the desired tape speed SP or SLP. The tape counter and SP or SLP will appear on the TV screen for approximately 4 seconds.

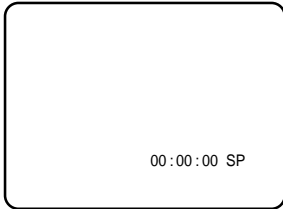

3. Set the TV/CATV option to the appropriate position (see "TV/CATV selection" on page E25).
TV: VHF/UHF channels
CATV: CABLE TV channels

4. Press the number buttons [0-9] or [CH] +/- to select the channel to be recorded.

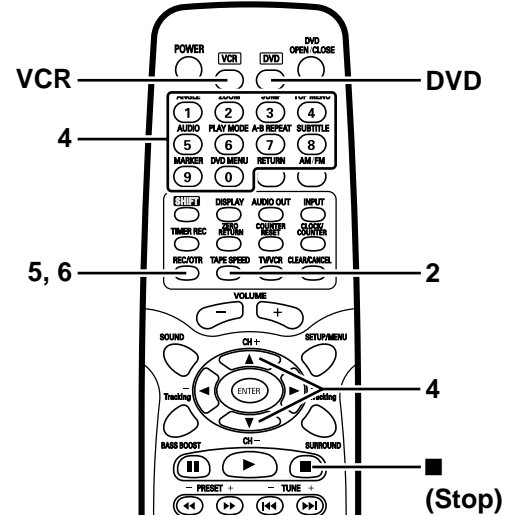
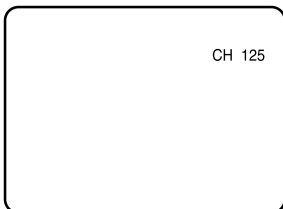

5. Press [REC/OTR].
6. Press [REC/OTR] again to stop recording after 30 minutes. Each additional press of [REC/OTR] will increase recording time as shown in the chart below, up to a maximum of 5 hours. The OTR and recording time will appear on the TV screen for approximately 4 seconds. And, REC will keep blinking on the FL display.

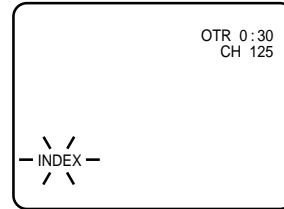

Press	Recording time	Press	Recording time
once	NORMAL REC	6 times	3:00
twice	0:30	7 times	4:00
3 times	1:00	8 times	5:00
4 times	1:30	9 times	NORMAL REC
5 times	2:00		

To cancel OTR

Press [■] or turn off the power. "■" will appear on the TV screen for approximately 4 seconds.

Note:

If you wish to watch the DVD playback during the OTR, press [DVD] to change to DVD mode and perform the DVD playback (see page E39).

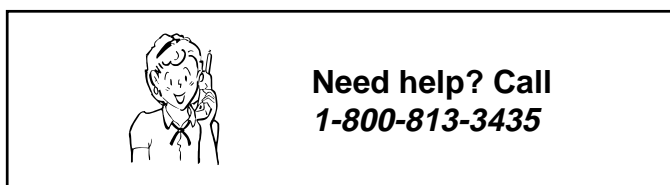



Timer Recording

Timer recording can be programmed on-screen with the remote control. The built-in timer allows automatic unattended recording of up to 8 programs within 1 month.

Preparation:

- Set the clock correctly (see pages E17 ~ E19).
- Press [VCR] to select the VCR mode. (The VCR indicator on the front panel will light.)
- Load a cassette tape with the erase prevention tab intact.
- Press the [DISPLAY] button to verify that the time and date are correct (see page E32).

Example: Program a timer recording for the 26th day, channel 125 (CATV), 11:00 – 11:30 PM on timer program number 1 (Tape speed: SLP).

1. Press [SETUP/MENU].
The "MENU" screen appears on the TV screen.

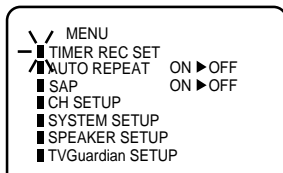

2. Select "TIMER REC SET", then press [ENTER].

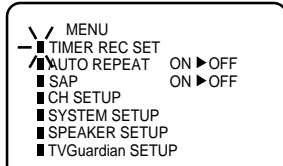

3. Press [▲] or [▼] to select one of the program line, then press [ENTER].

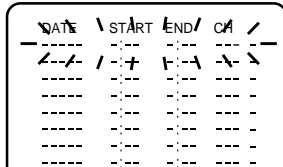

4. Press [▲] or [▼] to select the date, then press [ENTER].

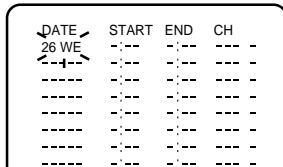

5. Set the start time, end time, channel and tape speed as in step 4.

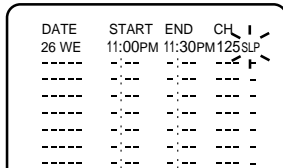

Notes:

- Press [CLEAR/CANCEL] to move cursor backward for correction.
- To record from external source, set the channel to "L". "L" will appear next to CH 125 (or 69).

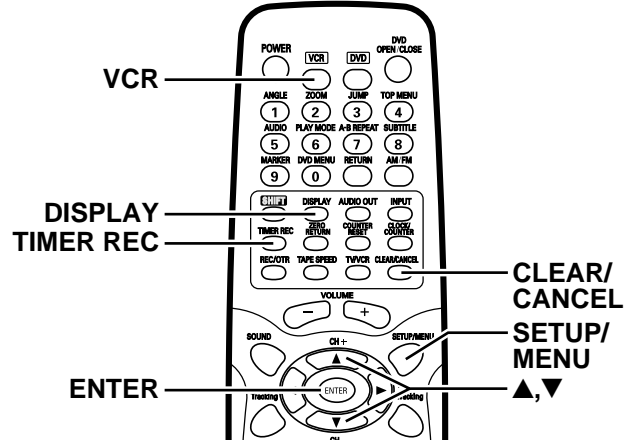

6. Repeat steps 3 ~ 5 for other programs.
 - To return to the normal screen, press [SETUP/MENU] twice.

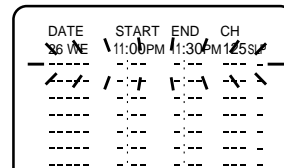

7. Press [TIMER REC].
The clock symbol (⌚) will appear on the FL display and the VCR stands by for recording. At the same time, VCR mode will change to DVD mode automatically. You can use DVD even if the VCR is in the Timer recording mode. If you do not use the DVD, turn the power off. The timer recording will start at 5 seconds before the time you predetermined.

Notes:

- If the clock symbol (⌚) does not appear on the FL display in spite of the pressing of [TIMER REC], the cassette may not have been loaded yet (see page E27).
- If the cassette is ejected in spite of the pressing of [TIMER REC], the erase prevention tab of the cassette may have been removed (see page E27).
- If the clock symbol (⌚) blinks on the FL display when the timer recording ended, the TV program has not been completely recorded because of an insufficient tape supply. Press [TIMER REC] to cancel the timer program or press [▲ EJECT] to remove the cassette tape.
- During timer recording standby mode, the VCR mode cannot be selected. To use the VCR, press [TIMER REC] at first, then press [VCR] to change to VCR mode. After you use the VCR, press [TIMER REC] again to put the VCR into timer recording standby mode.
- If you press [TIMER REC] during timer recording, the recording operation will be interrupted. If you press [TIMER REC] again within the programmed time, the recording operation will start again.
- After a power failure or disconnection of the power plug, all programmed recording settings and time display will be lost upon resumption of power. In this case, reset the clock (see page E19) and reprogram any timer recordings.



Timer recording special case

Weekly (e.g. WKL-TU: each Tuesday) or daily (e.g. MO-SA: Monday to Saturday) Timer recording.

Follow the procedure of timer recording on the previous page. On step 4, press [▲] or [▼] repeatedly until the desired setting appears. Then press [ENTER].

When you press [▼] repeatedly, the indicator at DATE will change as follows, in this case the day is Friday.

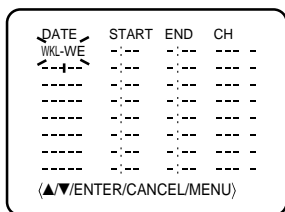
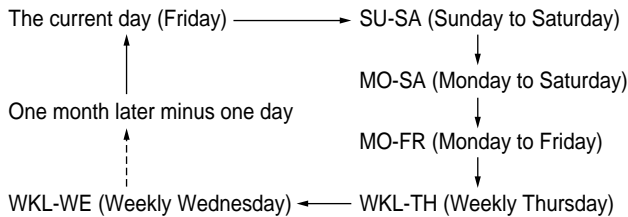

In case Timer programs-overlap

- Do not overlap timer programs as portions of the conflicting programs will be lost. The first recording time has priority over the next recording time as shown in the diagram below.

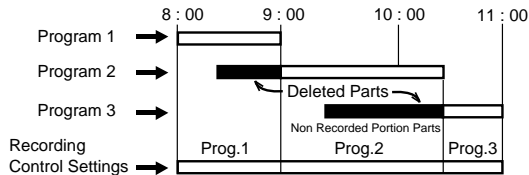

Notes:

- The daily/weekly recording can be made continuously until the recording is canceled or the tape reaches the end.
- During timer recording the automatic rewinding mechanism does not function.

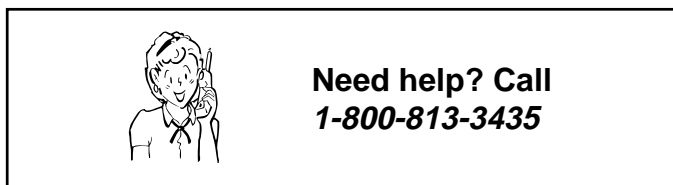

Confirmation/Cancellation of the Timer recording

- If the Timer has been activated, press [TIMER REC] to deactivate the Timer. The clock symbol (🕒) on the FL display will disappear.
- Press [VCR] to change to VCR mode.
- To confirm Timer program:** On step 2 on the previous page, select "TIMER REC SET" and press [ENTER]. Then the timer program list below will appear on the TV screen.

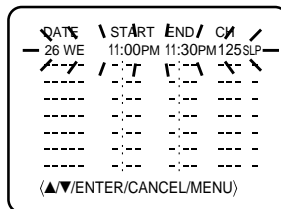

- To cancel Timer program:** Press [▲] or [▼] to select the unnecessary program, then press [CLEAR/CANCEL] to cancel the program.

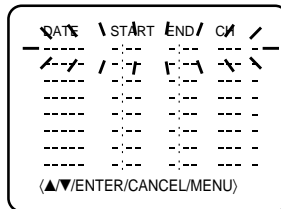

- Press [SETUP/MENU] until the menu screen is cleared.

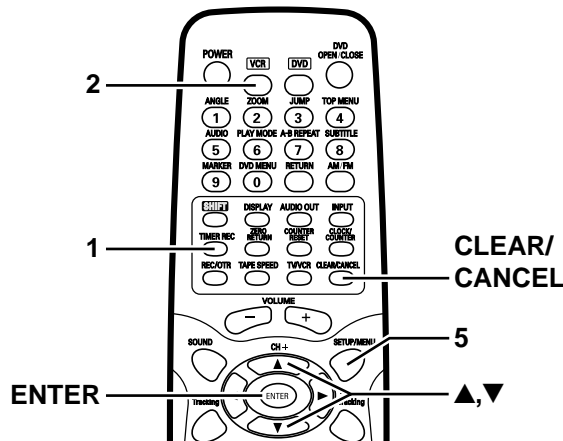

Notes:

- If there are other timer record programs remaining, [TIMER REC] must be pressed to reactivate the timer, otherwise the remaining timer record programs will be ignored.
- You cannot confirm the Timer program during timer recording operation.
- You can correct or cancel a programmed setting in program confirm mode.



Stereo Recording and Playback

The VHS Hi-Fi audio system permits high fidelity recording of MTS STEREO TV broadcasts.

When a MTS STEREO broadcast is received, the word STEREO will appear on the TV screen and the program can be viewed or recorded in stereo.

The Hi-Fi STEREO recording procedure is the same as for normal recordings.



Note:

When using a CATV system, stereo TV programs may be transmitted over a mono cable channel. In this case the word "STEREO" will not appear and the sound will be in mono.

Output selection

When viewing an MTS STEREO TV program, or playing a prerecorded VHS Hi-Fi STEREO videotape, press [AUDIO OUT] to select how the audio will be heard through the speakers. Normally set to the Hi-Fi STEREO position, this button can be set to the MONO position if the stereo broadcast or videotape audio is of poor quality. The "R" and "L" positions allow the audio from the Right or Left Hi-Fi channel to be heard over both TV speakers. This button has no effect when viewing a MONO videotape or TV program. Each time when you press the button, OUTPUT SELECTION display appears on the TV screen for several seconds. Refer to the chart below.

OUTPUT SELECTION	SOUND HEARD ON BOTH SPEAKERS
STEREO	STEREO
L ch	LEFT CHANNEL AUDIO
R ch	RIGHT CHANNEL AUDIO
MONO	MONO

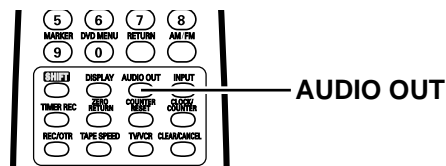

Notes:

- When playing back a tape that is not recorded in Hi-Fi stereo mode, the audio will automatically be monaural.
- When listening to a VHS Hi-Fi video tape or MTS broadcast through the VHF/UHF jack (Audio/Video cord not connected), the sound will be monaural.

Separate Audio Program (SAP)

Your VCR is fitted with a SAP broadcast system which enables you to switch to a separate audio program when viewing a selected channel.

This function applies only when the program is broadcast in multi-languages through the SAP broadcast system.

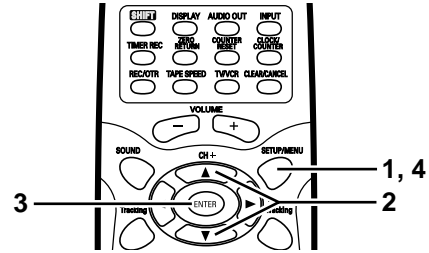

1. Press [SETUP/MENU].

The "MENU" screen appears on the TV screen.

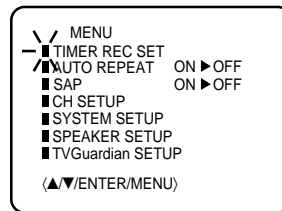

2. Press [▲] or [▼] to select "SAP".

3. Press [ENTER] to select "ON".

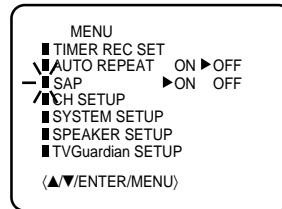

4. Press [SETUP/MENU] until the menu screen is cleared.

Listening to SAP

When the VCR is turned on or a channel selection is made, make certain the letters "SAP" appears on the TV screen. This means that the "Separate Audio Program" broadcasting is available.

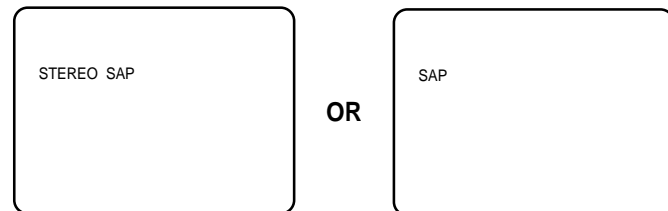



Duplicating a Video Tape

If you connect the VCR to another VCR or camcorder, you can duplicate a previously recorded tape. Make all connections before turning on the power.

Connection with second Video recorder

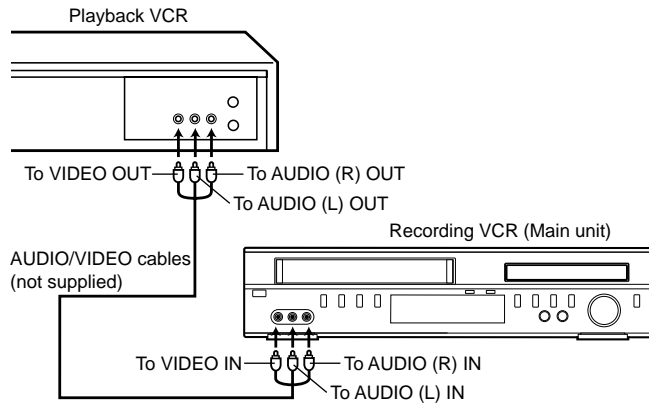

Connection with Video camera

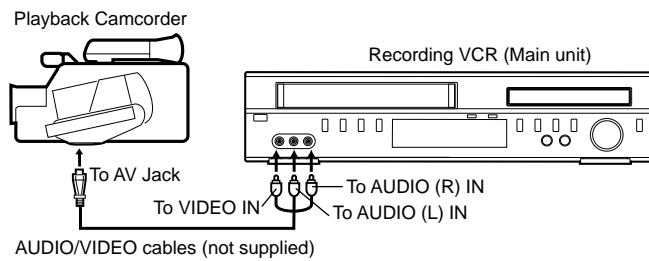

For duplicating a previously recorded tape from a camcorder, follow the camcorder manufacturer's instructions. A typical camcorder dubbing hookup is shown above.

1. Load a blank cassette tape with the erase prevention tab intact into the recording VCR. Load a previously recorded tape into the playback VCR or CAMCORDER.
2. Press [TAPE SPEED] to select the desired tape speed SP or SLP. "SP" or "SLP" appears on the TV screen.

 - It is recommended that you set the Speed to the SP mode on the recording VCR for best results.
3. Press [INPUT] to select AUDIO/VIDEO input position. "L" will appear on the FL display.

4. Press [REC/OTR], then press [II]. (Recording standby mode)

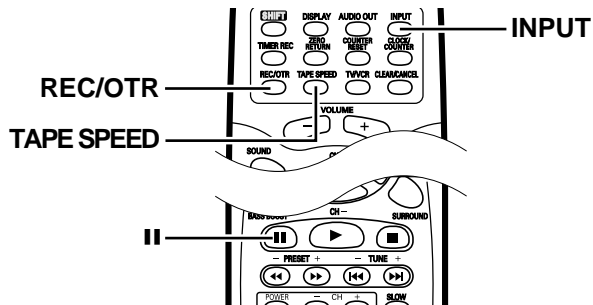

5. Press the play button on the playback VCR or CAMCORDER, then press the pause button. (Playback standby mode)
6. Release the recording pause and the playback still simultaneously to begin the duplicating process.

Recording a DVD/CD Disc

You can record disc material in DVD, Audio CD, etc. onto a Video tape with this VCR.

Preparation

- Turn ON the TV and select the corresponding video input.
- Load a cassette tape with the erase prevention tab intact.
- Load a DVD/CD disc.
- Press [VCR] to select the VCR mode. (The VCR indicator on the front panel will light.)

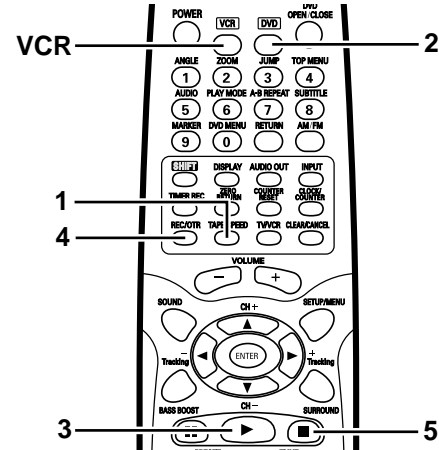

1. Press [TAPE SPEED] to select the desired tape speed SP or SLP. "SP" or "SLP" appears on the TV screen.
2. Press [DVD] to select the DVD mode.
3. Press [▶] to start playback.
4. Press [REC/OTR] to start recording. The unit will change to the VCR mode automatically and the playback picture or sound will be duplicated on the video cassette tape.
5. Press [■] if you finish recording. If you wish to stop a main unit disc, press [DVD] to change the DVD mode, then press [■].

Notes:

- You may not be able to record the beginning of the disc. Begin VCR recording once program playback commences on the DVD.
- **You can not record discs encoded with copy guard function. The following icon will show up on the TV screen.**

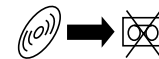



**Need help? Call
1-800-813-3435**



PLAYABLE DISCS

The following types of discs can be played on this unit.

Disc type and logo mark		Recorded content	Disc size	Maximum playing time
DVD Video		Audio + Video	5 inches (12 cm)	Approx. 4 hours (Single sided disc) Approx. 8 hours (Double sided disc)
			3 inches (8 cm)	Approx. 80 minutes (Single sided disc) Approx. 160 minutes (Double sided disc)
Audio CD		Audio	5 inches (12 cm)	74 minutes
			3 inches (8 cm)	20 minutes

Region Number

Region number (Regional restriction code) is built-in to the unit and DVD video discs.

Region number "1" or "ALL" of DVD video discs can be used on this unit.



DVD Video Disc

There are the marks on some DVD video disc package.

Examples:



Multiple languages



Multi-language subtitles



Multi-angle

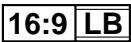

Multi-aspect



Region number



Closed caption

CAUTION:

- This unit can play back FUJICOLOR CD and KODAK Picture CD formats.
- Only the above types of discs can be played on this unit. DVD-ROM, CD-ROM, SVCD, CVD, VCD, etc. cannot be played.
- This unit is to be used exclusively with the NTSC color system. PAL and SECAM system discs cannot be used with this unit.
- Some CD-R/RWs can not be played back depending on the recording conditions.
- **For MP3/WMA CD, please see page E50.**
- **For KODAK Picture CD, please see page E52.**

DVD Video Disc

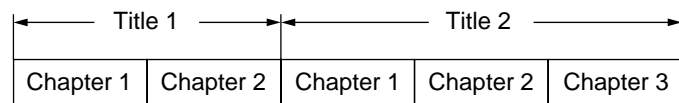

DVD video discs are divided into titles, and the titles are subdivided into chapters.

Audio CD Disc

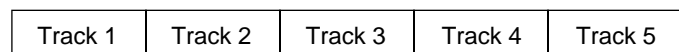

Audio CD discs are divided into tracks.

Handling, Storing and Cleaning Discs

- Fingerprints and dust should be carefully wiped from the signal surface of the disc (glossy side) with a soft cloth. Wipe in a straight motion from the center to the outside of the disc.
- Never use chemicals such as record cleaning sprays, antistatic sprays or fluids, benzene or thinner to clean the discs. These chemicals will permanently damage the plastic surface of the disc.
- To remove a disc from its storage case, press down on the center of the case and lift the disc out, holding it carefully by the edges.

- Discs should be returned to their cases after use to protect them from dust and scratches.
- To prevent warping the disc, do not expose it to direct sunlight, high humidity or high temperatures for extended periods of time.
- Do not apply paper or write anything on either side of the disc. Sharp writing instruments, or the inks used in some felt-tip pens, may damage the surfaces of the disc.



DISC PLAYBACK

Preparations

- Turn on the TV and select the video input source.
- Select the playback picture size according to the aspect ratio of the TV. (See "Setting Picture" in "INITIAL SETTINGS" on page E57.)

4:3 (Letterbox): 4:3 (Panscan): 16:9 (Wide screen):

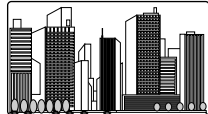
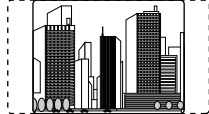

Basic Playback

Notes:

- Do not touch the disc tray while it is moving.
- Never place anything except a disc on the disc tray. Foreign objects can damage the unit.
- Do not apply excessive force to the disc tray.
- Discs must be placed on the disc tray one at a time.

When operation buttons are pressed, that operation is displayed on the TV screen. The display turns off after several seconds.

1. Press [POWER].
2. Press [DVD] to select DVD function.
 - "SANYO" logo appears on the TV screen.
 - The DVD indicator on the front panel will light.
 - "No Disc" appears on the TV screen.
3. Press [OPEN/CLOSE] (or [DVD OPEN/CLOSE] on the remote control).
 - "" appears on the TV screen and the disc tray opens.

Note:

To open or close the disc tray, be sure to press [DVD OPEN/CLOSE]. Do not press the disc tray with your hand.

4. Place the disc with the label facing up on the disc tray.

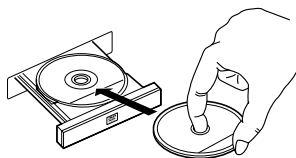

For 5-inch (12cm) disc

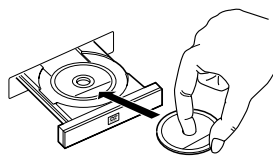

For 3-inch (8cm) disc

5. Press [OPEN/CLOSE] again.
 - The disc tray closes. "Reading" appears on the TV screen.
 - Note: Some discs may start playback automatically.

6. Press [] (or [PLAY]) to start playback.
 - "" appears.

Example:

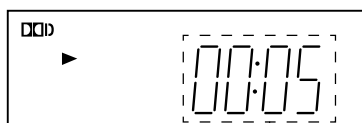

Elapsed playing time

Important Note:

- This instruction manual explains the basic instruction of the main unit using the remote control unit.
- Some DVD video discs have different functions that may not be explained in this instruction manual. You may need extra instructions. In this case, please follow the instructions displayed on the TV screen or jacket or case of the disc.
- "" may appear on the TV screen during operation. This icon means that the function is not available on the disc now.
- For improvement, on-screen displays subject to change without notice.

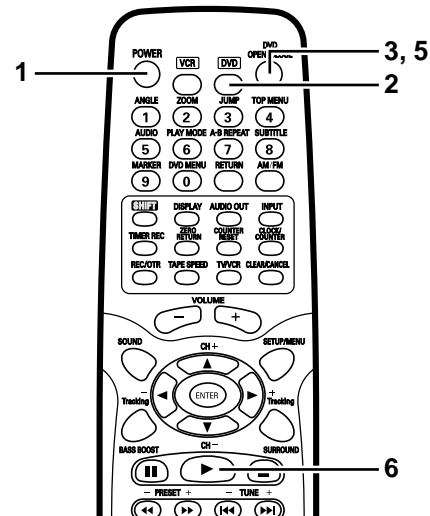
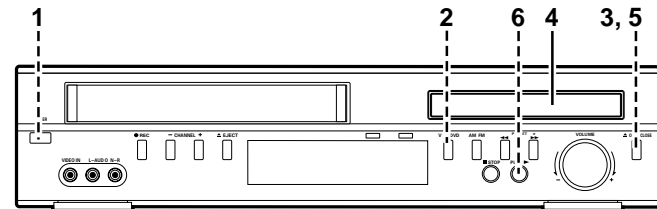

Notes:

- If the disc is loaded with the label side downward (and it is a single sided disc), or if a badly scratched disc is loaded, "Err (Error)" appears on the FL display and "Incorrect Disc" appears on the TV screen. If this occurs, load the disc correctly or replace the disc.
- In some discs, even if 4:3 is selected, the black bands may remain on the screen.

If a DVD disc menu screen appears on the TV screen...

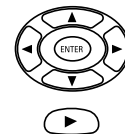

Select the desired menu by pressing [], [], [] or [] (or the number buttons), then press [ENTER] or [] (Play). Playback of the selected menu starts.

Note:

For more details, please refer to the jacket or case of the disc.



Stopping Playback

- Press **[■]** (or **[■ STOP]**) **once** during playback. "■" appears briefly on the TV screen. When you press **[▶]** (or **[PLAY ▶]**), playback starts automatically from the point where you stopped. "▶" appears on the TV screen.

Note:

Some discs may not resume playback.

- Press **[■]** (or **[■ STOP]**) **twice** during playback. "■" appears on the TV screen and playback stops completely. When you press **[▶]** (or **[PLAY ▶]**), playback starts from the beginning of the disc.

This product incorporates copyright protection technology that is protected by method claims of certain U.S. patents and other intellectual property rights owned by Macrovision Corporation and other rights owners. Use of this copyright protection technology must be authorized by Macrovision Corporation, and is intended for home and other limited viewing uses only unless otherwise authorized by Macrovision Corporation. Reverse engineering or disassembly is prohibited.

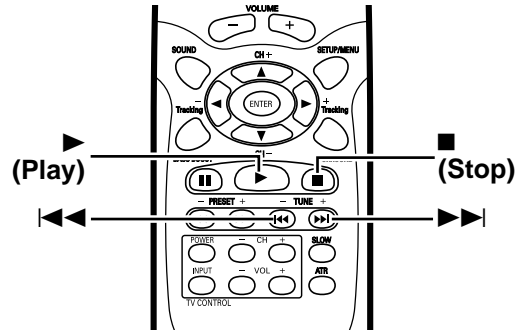
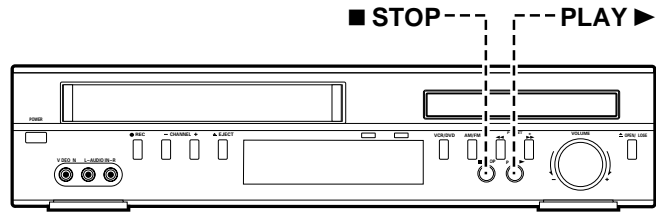

Chapter (Track) Skip

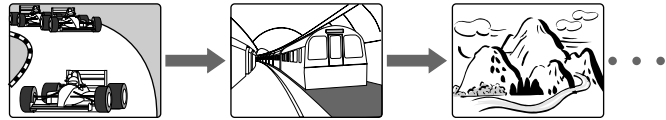

Skipping forward

Press **[▶▶]** during playback to skip to the next chapter (or track). "▶▶" appears on the TV screen.

A chapter (or track) is skipped each time the button is pressed.

Skipping backward

Press **[◀◀]** during playback to skip back to the beginning of the chapter (or track) currently play.

"◀◀" appears on the TV screen.

Press the button again immediately to skip back to the beginning of the previous chapter (or track).

Note:

You can skip only through the chapters, not over the title on the DVD disc.



**Need help? Call
1-800-813-3435**



Selecting a DVD Menu

Notes:

- The operation may differ depending on the disc used.
- Selecting a menu may not be possible on some discs.

1. Press [DVD MENU] while holding [SHIFT] down.
The main menu screen will appear.
2. Press [▲], [▼], [◀] or [▶] (or the number buttons) to select the desired menu.
3. Press [ENTER] or [▶].
The selected menu playback starts.

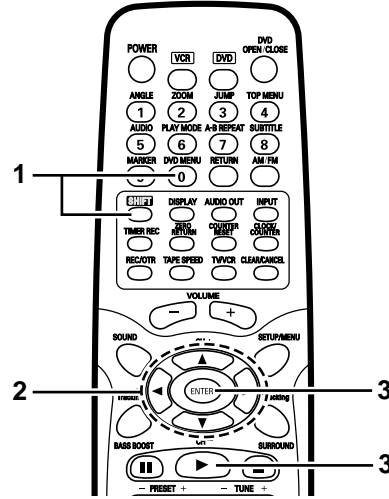

Selecting a Title Menu [DVD]

Notes:

- The operation may differ depending on the disc used.
- Selecting a title may not be possible on some discs.

1. Press [TOP MENU] while holding [SHIFT] down.
The title menu will appear (if the disc contains a title menu).
2. Press [▲], [▼], [◀] or [▶] (or the number buttons) to select the desired title.
3. Press [ENTER] or [▶].
The selected title playback starts.

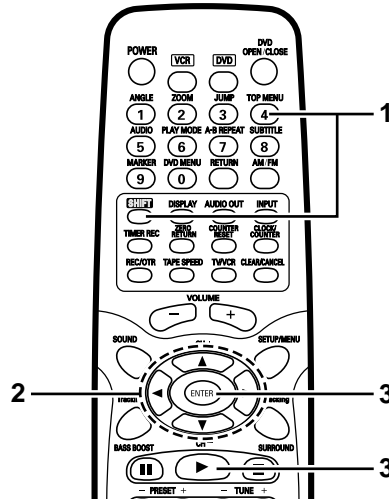

Important Note:

“” may appear on the TV screen during operation. This icon means that the function is not available on the disc now.



**Need help? Call
1-800-813-3435**



Title Search [DVD]

1. Press [JUMP] while holding [SHIFT] down during playback or in the stop mode.
The "Jump" screen appears on the TV screen.

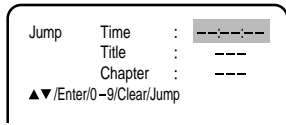

2. Press [▲] or [▼] to select the Title.
3. Press the number button(s) to enter the title number.
Example:
To select Title No.3, press [3].
To select Title No.10, press [1], then [0].
To select Title No.24, press [2], then [4].
Note:
If you make a mistake, press [CLEAR/CANCEL].
4. Press [ENTER].
Playback starts from the selected title.

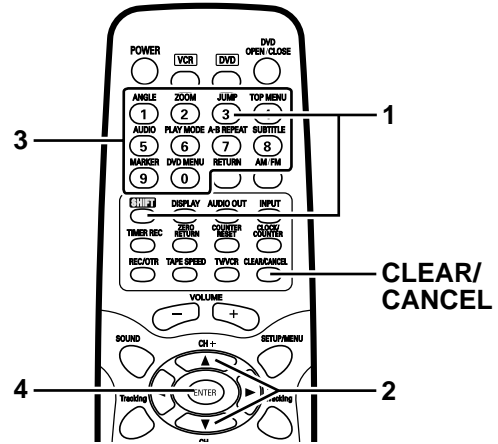

Important Note:

"👋" may appear on the TV screen during operation. This icon means that the function is not available on the disc now.

Chapter Search [DVD]

1. Press [JUMP] while holding [SHIFT] down during playback or in the stop mode.
The "Jump" screen appears on the TV screen.

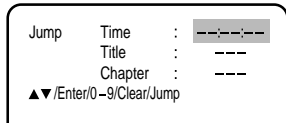

2. Press [▲] or [▼] to select the Chapter.
3. Press the number button(s) to enter the chapter number.
Example:
To select Chapter No.3, press [3].
To select Chapter No.10, press [1], then [0].
To select Chapter No.24, press [2], then [4].
Note:
If you make a mistake, press [CLEAR/CANCEL].
4. Press [ENTER].
Playback starts from the selected chapter.

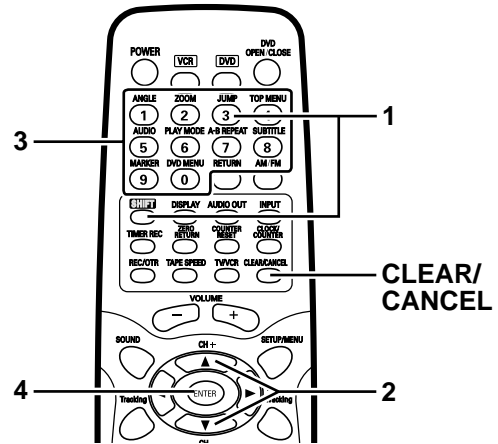

Need help? Call
1-800-813-3435

Time Search [DVD]

1. Press [JUMP] while holding [SHIFT] down during playback.
The "Jump" screen appears on the TV screen.

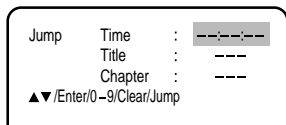

2. Press [▲] or [▼] to select the Time.
3. Press the number button(s) to enter the time.
Example:
20 minutes 5 seconds Press [2], [0], [0] and [5].
42 minutes 39 seconds Press [4], [2], [3] and [9].
1 hour 4 minutes 35 seconds Press [1], [0], [4], [3] and [5].
Note:
If you make a mistake, press [CLEAR/CANCEL].
4. Press [ENTER].
Playback starts from the searched time.

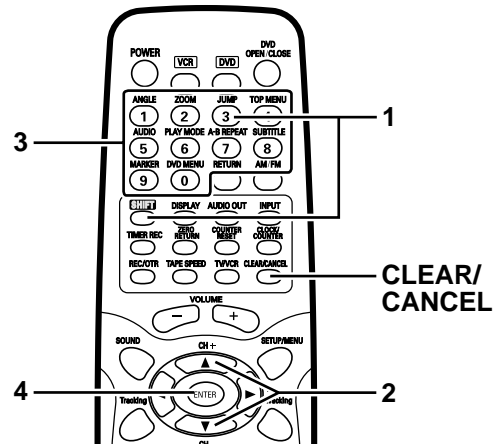



Time Search [CD]

1. Press [JUMP] while holding [SHIFT] down during playback or in the stop mode.
The "Jump" screen appears on the TV screen.

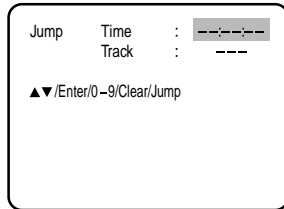

2. Press [▲] or [▼] to select the Time.
3. Press the number button(s) to enter the time.
Example:
2 minutes 5 seconds Press [2], [0] and [5].
42 minutes 39 seconds Press [4], [2], [3] and [9].
Note:
If you make a mistake, press [CLEAR/CANCEL].
4. Press [ENTER].
Playback starts from the searched time in the track (or from the beginning of the disc).

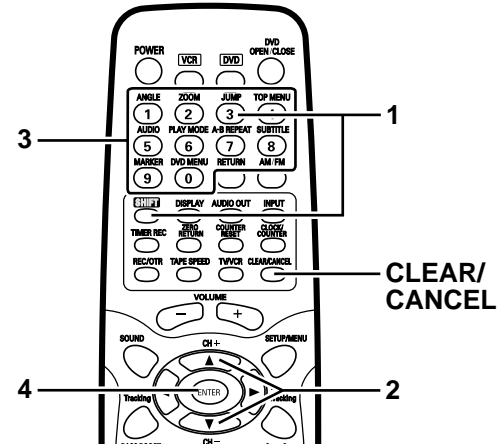

Track Search [CD]

1. Press [JUMP] while holding [SHIFT] down during playback or in the stop mode.
The "Jump" screen appears on the TV screen.

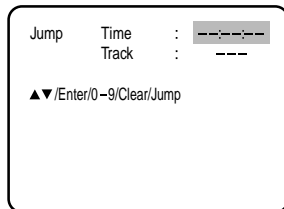

2. Press [▲] or [▼] to select the Track.
3. Press the number button(s) to enter the track.
Example:
To select Track No. 3, press [3].
To select Track No. 10, press [1], then [0].
To select Track No. 24, press [2], then [4].
Note:
If you make a mistake, press [CLEAR/CANCEL].
4. Press [ENTER].
Playback starts from the selected track.

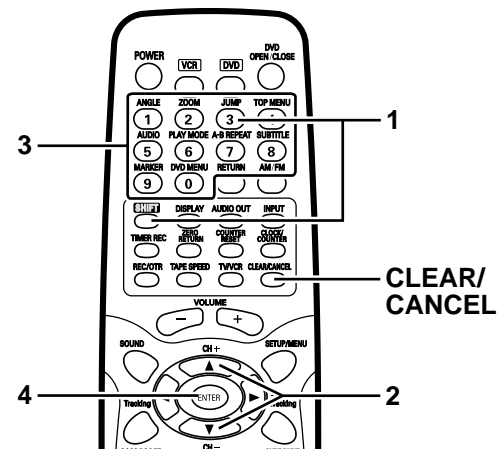

Note:
Please refer to "Example for Audio CD" in "Selecting On-Screen Information" on page E49.

Important Note:

"👋" may appear on the TV screen during operation. This icon means that the function is not available on the disc now.



**Need help? Call
1-800-813-3435**



Fast Playback

Fast forward playback

Press [▶▶] repeatedly to select the fast speed forward playback. Each time the button is pressed, the speed is changed.

▶▶ → ▶▶▶ → ▶▶▶▶ → ▶▶▶▶▶ (4 steps)

Press [▶] to return to normal playback.

Fast reverse playback

Press [◀◀] repeatedly to select the fast speed reverse playback. Each time the button is pressed, the speed is changed.

◀◀ → ◀◀◀ → ◀◀◀◀ → ◀◀◀◀◀ (4 steps)

Press [▶] to return to normal playback.

Note:

The sound is muted during fast playback in DVD.

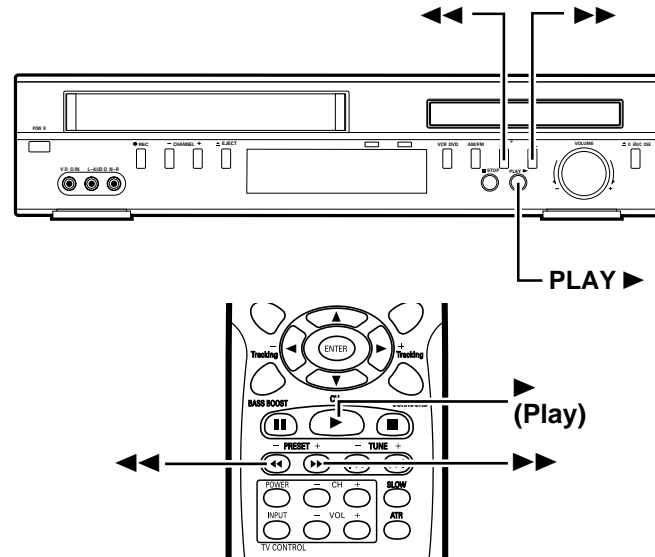

Slow Motion Playback [DVD]

Forward slow playback

Press [SLOW] repeatedly to select the forward slow speed playback. Each time the button is pressed, the speed is changed.

▶ 1/2 → ▶ 1/4 → ▶ 1/6 → ▶ 1/7 (4 steps)

Press [▶] to return to normal playback.

Notes:

- The sound is muted during slow motion playback.
- Slow motion playback is operated forward only.

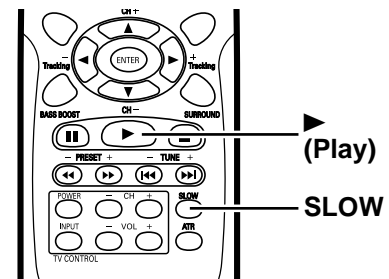

Important Note:

“✋” may appear on the TV screen during operation. This icon means that the function is not available on the disc now.

Still Picture (Pause)

Press [⏸] during playback.

- “⏸” appears on the FL display.
- “⏸” appears on the TV screen.

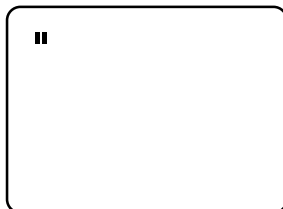

Press [▶] to return to normal playback.

[DVD]

Still picture mode

[CD]

Pause mode

Note: The sound is muted.

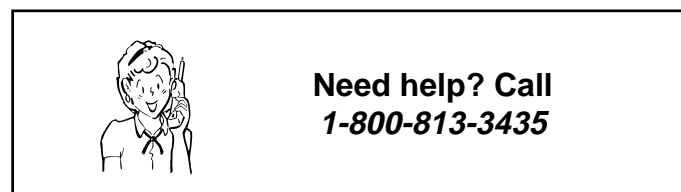
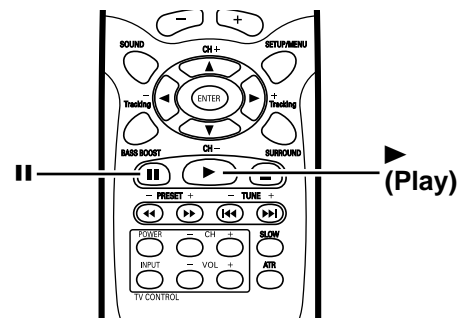



Frame by Frame Advance Playback [DVD]

Press [II] during still picture.

- "II" appears on the TV screen.



Each time the button is pressed, the picture advances one frame. Press [▶] to return to normal playback.

Notes:

- The sound is muted.
- Frame playback is operated forward only.

Picture Zoom [DVD]

1. Press [ZOOM] while holding [SHIFT] down during normal/slow/fast playback or still picture. The central part of the picture is magnified, and "Q 1" appears on the TV screen.



- Each time the button is pressed, the zoom mode will be changed as follows:

Q 1 → Q 2 → Q 3 → Q Off

- Press [▲], [▶], [▼] or [◀] to change the zoom point.

2. Press [ZOOM] while holding [SHIFT] down to select "Q Off" to return to the original screen.

Note:

Picture Zoom may not work on some discs.

Viewing from a Desired Camera Angle (Multi-Angle) [DVD]

Some DVD video discs may contain scenes which have been shot simultaneously from a number of different camera angles. The jacket or case of discs that are recorded with angles will be marked.

Example:



Note:

The recorded angles differ depending on the disc used.

1. Play the disc that is recorded with angles.
2. Press [ANGLE] repeatedly while holding [SHIFT] down until the desired angle appears. Example:

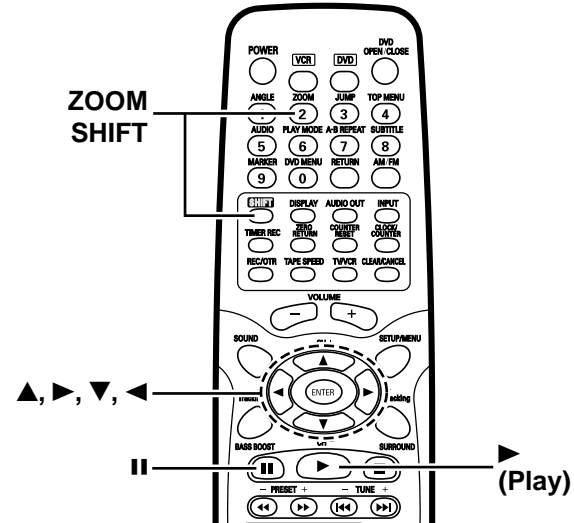
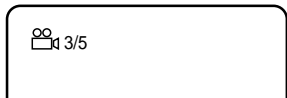

Important Note:

"⏸" may appear on the TV screen during operation. This icon means that the function is not available on the disc now.

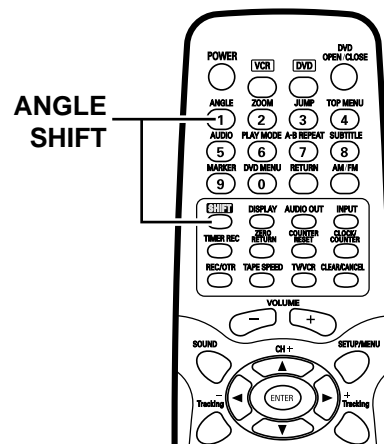
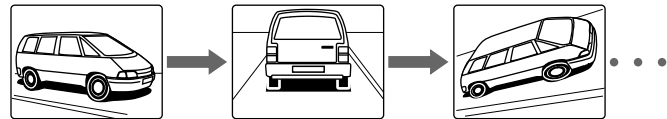

Normal Repeat Playback

[DVD]

1. Press [PLAY MODE] while holding [SHIFT] down during playback or stop mode.
The "Play Mode" screen ("Repeat") appears.

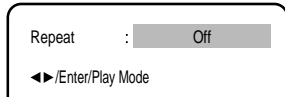

2. Press [◀], [▶] or [ENTER] once or twice to select "Chapter" or "Title".

Repeat: Chapter	Repeat of chapter being played
Repeat: Title	Repeat of title being played
Repeat: Off	Normal playback mode

The selected repeat mode may work.

3. Press [PLAY MODE] while holding [SHIFT] down again to close the screen.

[CD]

1. Press [PLAY MODE] while holding [SHIFT] down during playback or stop mode.
The "Play Mode" screen ("Play Mode" and "Repeat") appears.
2. Press [▼] to skip Play Mode and select "Repeat".

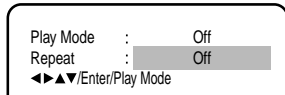

3. Press [◀], [▶] or [ENTER] once or twice to select "Track" or "All".

Repeat: Track	Repeat of track being played
Repeat: All	Repeat all tracks
Repeat: Off	Normal playback mode

The selected repeat mode may work.

4. Press [PLAY MODE] while holding [SHIFT] down again to close the screen.

Note:

In case of stop mode, press [▶] to start Repeat playback.

Designated Range Repeat Playback (A-B Repeat)

1. Press [A-B REPEAT] while holding [SHIFT] down during playback at the beginning of the section you want to repeat (Point A).

- "A-" appears on the TV screen.

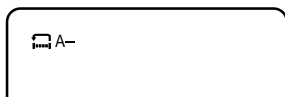

2. Press [A-B REPEAT] while holding [SHIFT] down again at the end of the section you want to repeat (Point B).

- "A-B" appears on the TV screen.

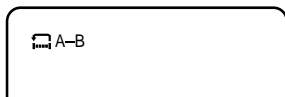

The section between points A and B is played repeatedly.

3. To return to normal playback, press [A-B REPEAT] while holding [SHIFT] down again.

- "Off" appears on the TV screen.

Notes:

- Normal repeat playback or A-B repeat playback mode may not work correctly with some discs.
- During the Random/Programmed playback, the A-B repeat feature will not operate.

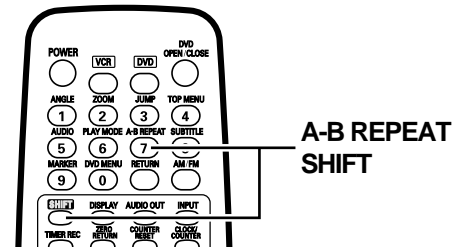
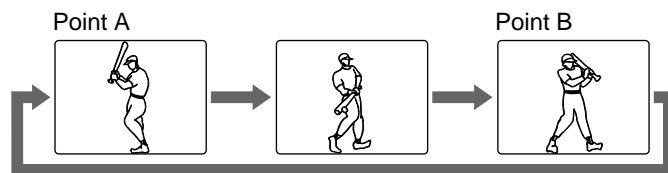
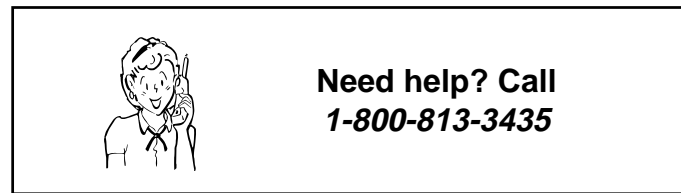
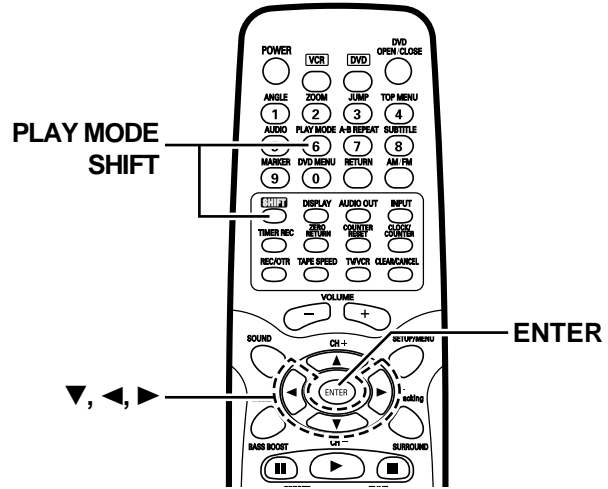

Random Playback [CD] [MP3] [WMA] [JPEG]

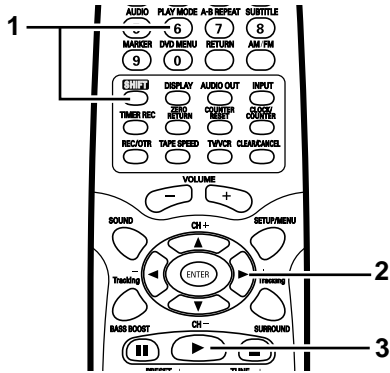

1. Press [PLAY MODE] while holding [SHIFT] down during playback or stop mode.
The "Play Mode" screen ("Play Mode" and "Repeat") appears.



2. Press [▶] to select "Random".

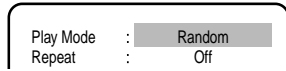

3. Press [▶] to start Random Playback.

In case of Random Playback of JPEG file, press [▶▶] to proceed the Random playback.

Note:

To stop Random Playback completely, select "Off" in step 2.

Programmed Playback [CD] [MP3] [WMA] [JPEG]

Up to 12 selections can be programmed.

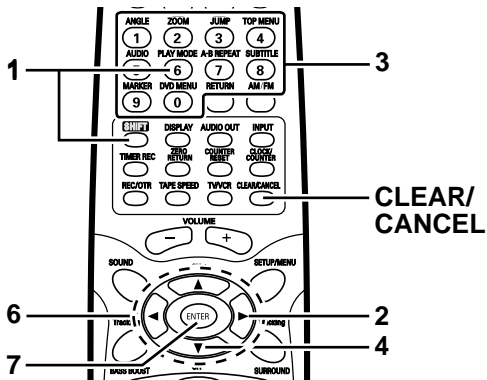

Programming procedure

1. Press [PLAY MODE] while holding [SHIFT] down in the stop mode.
The "Play Mode" screen ("Play Mode" and "Repeat") appears.



2. Press [▶] to select "Program".
The "Program" screen appears.

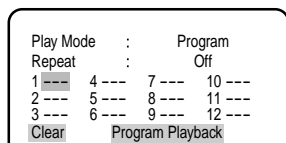

3. Press the number buttons to select the track number.

Example:

To select Track No.3, press [3].

To select Track No.10, press [1], then [0].

To select Track No.24, press [2], then [4].

Notes:

- If you make a mistake, press [CLEAR/CANCEL].
- To quit the "Play Mode" screen, press [PLAY MODE] while holding [SHIFT] down.

4. Press [▼] to move the highlighted box down.

Example:

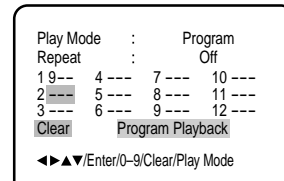

5. Repeat steps 3 ~ 4 above to select another track.

6. Press [▲], [▼], [◀] or [▶] to select "Program Playback" on the TV screen.

7. Press [ENTER].

Program playback starts in the programmed order.

In case of Program Playback of JPEG file, press [▶▶] to proceed the Program Playback.

To return to normal playback, press [PLAY MODE] while holding [SHIFT] down and select Play Mode "Off".

- The program is canceled when you open the disc tray or turn the power off.

To clear the program one by one

1. Repeat the steps 1 ~ 2 as described in "Programming procedure" to open the "Program" screen.

2. Press [▲], [▼], [◀] or [▶] to select the track number.

3. Press [CLEAR/CANCEL].

To clear all the programs

1. Repeat the steps 1 ~ 2 as described in "Programming procedure" to open the "Program" screen.

2. Press [▲], [▼], [◀] or [▶] to select "Clear".

3. Press [ENTER].

To change the program

1. Repeat the steps 1 ~ 2 as described in "Programming procedure" to open the "Program" screen.

2. Press [▲], [▼], [◀] or [▶] to select the track number.

3. Press the number buttons to select the track number to be replaced.

Note:

To quit the "Play Mode" screen, press [PLAY MODE] while holding [SHIFT] down.

Important Note:

"⏏" may appear on the TV screen during operation. This icon means that the function is not available on the disc now.

Selecting Subtitle Language [DVD]

This operation works only with discs on which multiple subtitle languages are recorded.

1. Press [SUBTITLE] while holding [SHIFT] down during playback. The subtitle language mark appears on the TV screen. (Example: 2/3 Spa)
If " Off" appears, press the button again.



2. Press [SUBTITLE] while holding [SHIFT] down repeatedly until the desired subtitle language appears on the TV screen. Example:

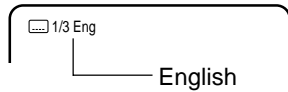

After few seconds, " Off" disappears.

Selecting Audio Soundtrack Language (Multi-Language) [DVD]

This operation works only with discs on which multiple audio soundtrack languages are recorded.

1. Press [AUDIO] while holding [SHIFT] down during playback.
2. Press [AUDIO] while holding [SHIFT] down repeatedly until the desired language appears on the TV screen.

Example:

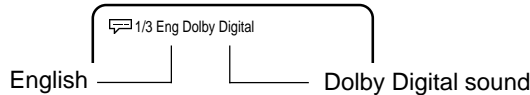

Notes:

- When the desired language is not selected even if the button is pressed, the language is not available on the disc.
- When the power is turned on or the disc is replaced, select the language again.
- If the language is not recorded on the disc, only the available language on the disc will be heard.

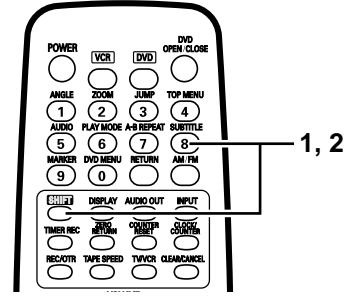

Notes:

- In some cases, the subtitle language is not changed to the selected one.
- When a disc supporting closed caption is played, the subtitle and the closed caption may overlap each other on the TV screen. In this case, turn the subtitle off.
- When the desired language is not selected even if the button is pressed, the language is not available on the disc.
- When the power is turned on or the disc is replaced, select the subtitle language again.
- If the subtitle language is not necessary, press [SUBTITLE] while holding [SHIFT] down to select " Off".

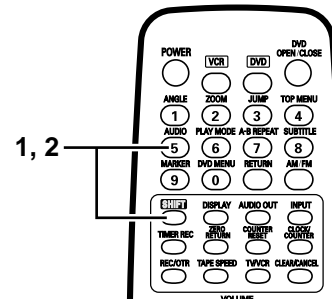
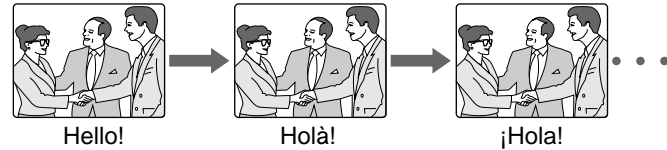

Need help? Call
1-800-813-3435

Karaoke Playback [DVD]

You can turn the vocal on or off recorded on the DVD KARAOKE.

1. During DVD KARAOKE disc playback, press [AUDIO] while holding [SHIFT] down. "" (karaoke symbol) appears on the TV screen. Example:

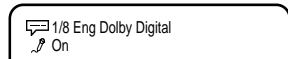

2. Press [◀] or [▶] to select "On" or "Off".
On: The primary vocal is output when it is recorded on the disc.
Off: The primary vocal is not output.

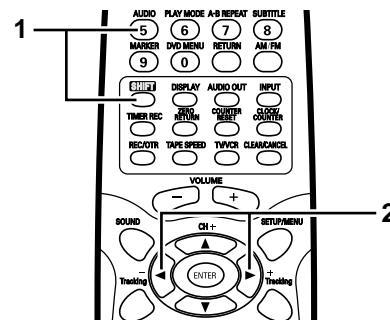

Notes:

- The vocal output feature is used during playback of Dolby Digital (multi-channel) recorded DVD KARAOKE discs. This feature allows you to turn off vocal audio tracks, or restore them for back-ground accompaniment.
- When playing KARAOKE, connect appropriate audio equipment such as an amplifier to the DVD.

Selecting On-Screen Information

Example for DVD:

Press [DISPLAY] repeatedly to show the disc information (Title, Chapter, Title elapsed playing time, Language, etc.).

1. Press [DISPLAY] during playback.

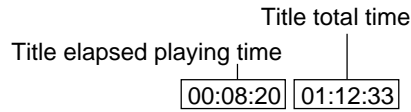

2. Press [DISPLAY] again.

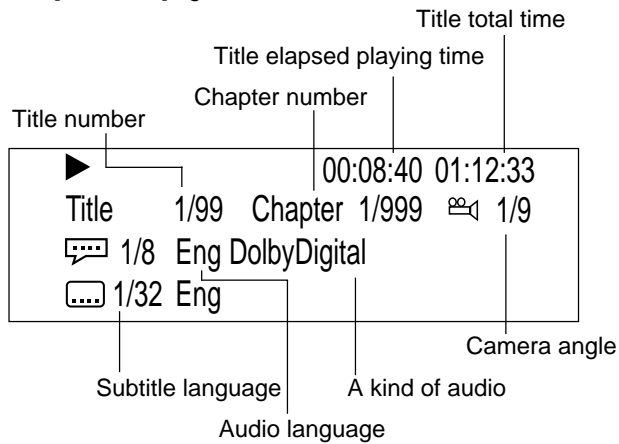

3. Press [DISPLAY] to close the disc information.

Example for Audio CD:

When a CD is loaded or playback is started, the disc information may appear on the TV screen.

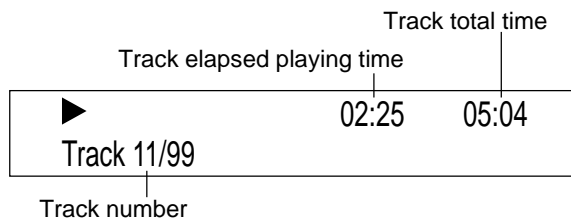

Important Note:

“” may appear on the TV screen during operation. This icon means that the function is not available on the disc now.

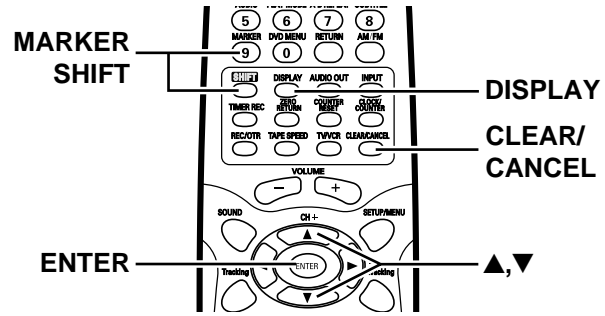
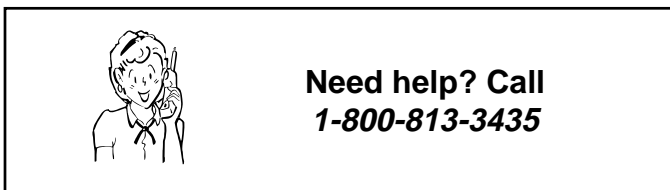

Marking Desired Scenes [DVD] [CD]

The unit stores the points that you want to watch (or listen it) again. You can resume playback from that scene.

Marking the Scenes

1. Press [MARKER] while holding [SHIFT] down during playback. The “Marker” screen appears.

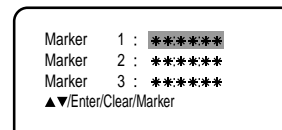

2. Select the blank Marker using [▲] or [▼], then press [ENTER] at the desired scene.

Example:

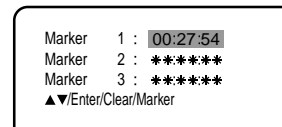

- Up to 3 scenes can be selected.
- Repeat this procedure to set the other 2 scenes.

3. To quit the Marker screen, press [MARKER] while holding [SHIFT] down.

Returning to the Scenes

1. Press [MARKER] while holding [SHIFT] down during playback or stop mode.

Example:

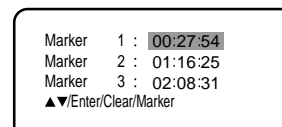

2. Press [▲] or [▼] to select the Marker 1 ~ 3.

Example:

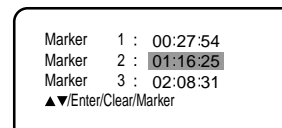

3. Press [ENTER]. Playback starts from the marked scene.
 - To quit the Marker screen, press [MARKER] while holding [SHIFT] down.

To Cancel the Mark

1. Press [MARKER] while holding [SHIFT] down.
2. Press [▲] or [▼] to select the Marker 1 ~ 3.
3. Press [CLEAR/CANCEL].

Notes:

- You may not mark it on some discs.
- The marking is canceled when you open the disc tray or turn the power off.

MP3/WMA CD OPERATION

Before Starting

This unit can play back the CD that has recorded music data, MP3 or WMA (Windows Media Audio) files.

- The file system is ISO9660 Level 1 and Level 2.
- If the CD has both audio CD tracks and MP3/WMA files, only audio CD tracks are played.
- It would take 30 seconds or more for this unit to read MP3/WMA files depending on its structure.
- This unit can recognize up to 200 files or 50 folders per disc. The CD with 201 files or 51 folders and over is not available to this unit.
- MP3/WMA CDs may not be played in the recorded order.
 1. Please use the MP3 or WMA software with the function that can record data alphabetically or numerically.
 2. Please refrain from making many sub-folders by preference.

However, some CD-R/RWs cannot be played back depending on the recording conditions.

Before playing back MP3 or WMA files, please read the following.

MP3 CD

- MP3 files must have the extension letters, ".MP3" or ".mp3".
- Standard, sampling frequency, and the bit rate:
MPEG-1 Audio
32kHz, 44.1kHz, 48kHz
32kbps ~ 320kbps (constant bit rate or variable bit rate)
- The recommend recording setting for a high-quality sound is 44.1kHz of sampling frequency and 128kbps of constant bit rate.

WMA CD

- When creating a WMA disc, be sure the copyright function is off.
- WMA files must have the extension letters, ".WMA" or ".wma".
- Standard, sampling frequency, and the bit rate:
WMA version 7, and 8
32kHz, 48kbps
44.1kHz, 48kbps ~ 192kbps
48kHz, 128kbps ~ 192kbps
- DRM files cannot be played back.
- The file recorded by mono, 48kHz, 48 kbps is not available to this unit.

Microsoft, Windows Media, and Windows Logo are trademarks or registered trademarks of Microsoft Corporation in both the United States and other countries.

LIMITATIONS ON DISPLAY

- The maximum number for display is 16 letters.
- Available letters for display are the following: capital or small alphabets of A through Z, and numbers of 0 through 9.
- Other letters than those above are replaced in "-" (hyphen).

CAUTION:

- Some MP3/WMA CDs cannot be played back depending on the recording conditions.
- The CD has no music data or non-MP3/WMA files cannot be played back.

MP3/WMA CD Playback

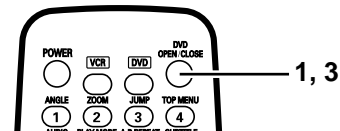
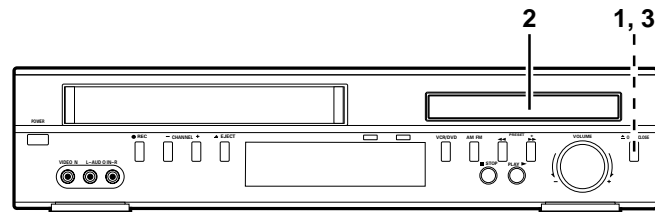

1. Press [OPEN/CLOSE].
 - "▲" appears on the TV screen and the disc tray opens.

Note:
To open or close the disc tray, be sure to press [OPEN/CLOSE]. Do not press the disc tray with your hand.
2. Place the disc with the label facing up on the disc tray.

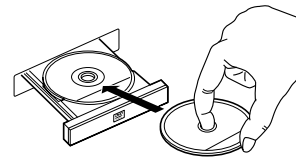

3. Press [OPEN/CLOSE].
The disc tray closes.
 - "Reading" appears on the TV screen.
 - A file list (table of contents in the root directory) appears on the TV screen.

Example:

Operation	Media type	File type	File number	Elapsed time
CD-R	■		-/72	--:--
Folder	■	Pops		
1	🎵	Japan	8	flower
2	🎵	Bay Bridge	9	Lies and Truth-
3	🎵	CLOSE MY EYES	10	winter fall
4	🎵	DIVE TO BLUE	11	Rain
5	🎵	Honey	12	Strawberry
6	🎵	BLUE EYES	13	Welcome party
7	🎵	Blurry Eyes	14	Thailand

◀▶▲▼/0-9/Enter/Play Mode

Important Note:

"👉" may appear on the TV screen during operation. This icon means that the function is not available on the disc now.



Need help? Call
1-800-813-3435

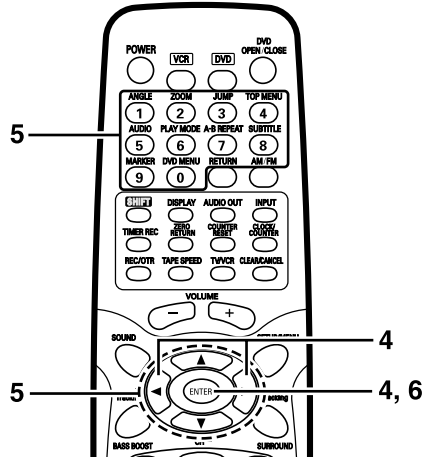

- Press [◀] or [▶] or [ENTER] to select folder.
- Press [▲], [▼], [◀], [▶] or number buttons [0–9] to select your desired file.
 - In case the folder include more than 15 files, press [◀] or [▶] to display next file list.

Example:

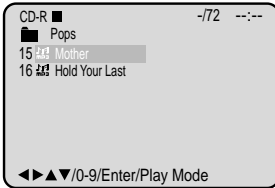

- Press [ENTER] to start playback.
 - The letter's color in the highlighted box turns green.

Example:

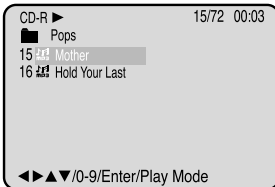

Notes:

- If the disc is loaded with the label side downward, or if a badly scratched disc is loaded, "Err (Error)" appears on the FL display and "Incorrect Disc" appears on the TV screen. If this occurs, load the disc correctly or replace the disc.
- During MP3/WMA CD Playback, you can not use Fast Playback and Designated Range Repeat Playback (A-B Repeat) functions.

Stopping Playback

Press [■] **once** during playback. "■" appears on the TV screen. Press [▶] to resume playback (from the stopped point). To stop the playback completely, press [■] **twice**.

Pause

Press [⏸] during playback.

- "⏸" appears on the TV screen.
- "⏸" appears on the FL display.

Note: The sound is muted.

Press [▶] to return to normal playback.

Important Note:

"🚫" may appear on the TV screen during operation. This icon means that the function is not available on the disc now.

File (Track) Skip

Skipping forward

Press [▶▶] during playback to skip to the next file.

"▶▶" appears on the TV screen.

Each time the button is pressed, a file is skipped.

Skipping backward

Press [◀◀] during playback to skip back to the beginning of the file currently play.

"◀◀" appears on the TV screen.

Press the button again immediately to skip back to the beginning of the previous file.

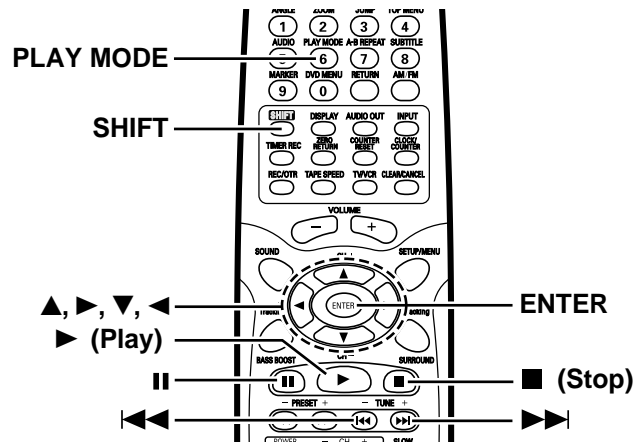

Repeat Playback

- Press [PLAY MODE] while holding [SHIFT] down during playback or stop mode.

The "Play Mode" screen ("Play Mode" and "Repeat") appears on the TV screen.

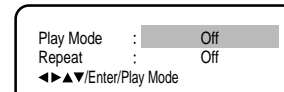

- Press [▼] to select "Repeat".

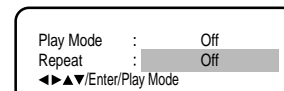

- Press [◀], [▶] or [ENTER] repeatedly to select "Track" (file) or "All".

Repeat: Track	Repeat of track (file) being played
Repeat: All	Repeat all tracks (files)
Repeat: Off	Normal playback mode

The selected repeat mode may work.

- Press [PLAY MODE] while holding [SHIFT] down again to close the screen.

- The file list appears on the TV screen with operation display ("Repeat Track" or "Repeat All").

In case of stop mode, press [▶] to start Repeat Playback. To resume normal playback, select Repeat "Off".

Note:

Repeat Playback may not work correctly with some discs.

Programmed Playback

Please see page E47.

Random Playback

Please see page E47.

PICTURE DISC OPERATION

KODAK Picture CD Playback

With KODAK Picture CD, it's easy to turn film into pictures you can email from your PC and view on this unit!
Just bring your film in for processing, and check the box for KODAK Picture CD. You'll get back your prints and negatives as usual - plus you'll get a special CD that contains your pictures along with software that lets you view, enhance, share, and print your pictures from your computer and view them on this unit.

To play the picture one by one

1. Load the disc with the label facing up on the disc tray. (Please refer to "MP3/WMA CD OPERATION" on page E50.)
 - "Picture CD" appears briefly on the TV screen.
 - The first thumbnail pictures (maximum 9-picture) appear on the TV screen.

Example:

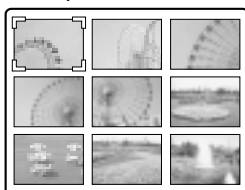

- If you press [TOP MENU] while holding [SHIFT] down, the file list appears.

2. Press [▲], [▶], [▼] or [◀] to move the cursor to the desired picture.
 - To go to the next or previous thumbnail pictures, press [▶▶] or [◀◀].
 - **Selecting a picture from the file list**
 - 1) Press [TOP MENU] while holding [SHIFT] down, the file list appears on the TV screen.

Example:

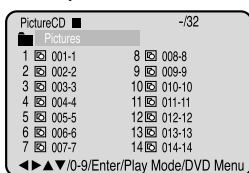

- If you press [DVD MENU] while holding [SHIFT] down, the thumbnail pictures appear.

- 2) Press [◀] or [▶] or [ENTER] to select folder.
 - 3) Press [▲], [▼], [◀], [▶] or number buttons [0-9] to select your desired file.
 - In case the folder includes more than 15 files, press [◀] or [▶] to display next file list.
3. Press [ENTER] (or [▶ (Play)]) to play the selected picture.
 - **If the picture appears upside down or sideways...**
Press [ANGLE] repeatedly while holding [SHIFT] down until it's right side up.
"⏪", "⏩", "⏴", or "⏵" appears briefly on the TV screen.
 - Press [▶▶] or [◀◀] to skip to the next or previous picture.
 - To stop the playback, press [■]. The thumbnail pictures appear on the TV screen.

Picture Zoom

Please see page E45.

KODAK and Picture CD are registered trademarks of Eastman Kodak Company.

Important Note:

"🚫" may appear on the TV screen during operation. This icon means that the function is not available on the disc now.

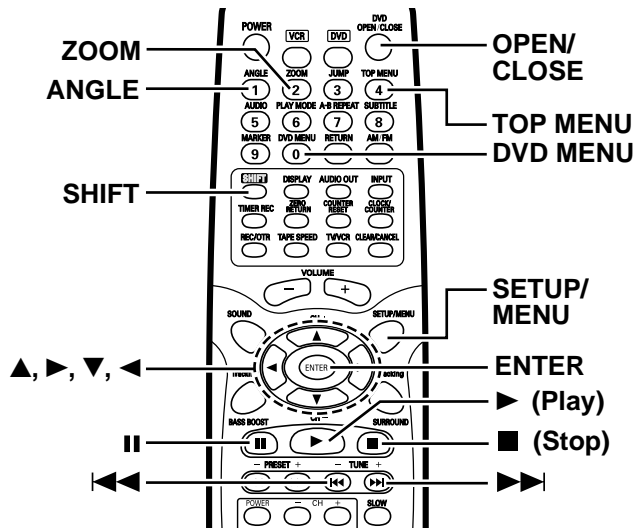

To start the slide show

Preparation:

1. If the disc loaded, remove the disc first.
2. Set "JPEG Interval" setting to "5 Seconds", "10 Seconds" or "15 Seconds" (see page E57).

1. Load the disc with the label facing up on the disc tray. (Please refer to "MP3/WMA CD OPERATION" on page E50.)
 - "Picture CD" appears briefly on the TV screen.
 - The first thumbnail pictures (maximum 9-picture) appear on the TV screen.
2. Press [▲], [▶], [▼] or [◀] to move the cursor to the desired picture.
 - To go to the next or previous thumbnail pictures, press [▶▶] or [◀◀].
 - You can also select the desired picture from the file list. See "Selecting a picture from the file list" as left described.
3. Press [ENTER] (or [▶ (Play)]) to start slide show from the selected picture.
 - If you press [■] during the slide show, the slide show stops temporary. "■" appears briefly on the picture. Press [▶ (Play)] (or [▶▶]) again to resume the slide show.
 - **If the picture appears upside down or sideways, please do the following steps.**
 - 1) Press [■], if necessary.
 - 2) Press [ANGLE] repeatedly while holding [SHIFT] down until it's right side up.
"⏪", "⏩", "⏴", or "⏵" appears briefly on the TV screen.
 - 3) Press [▶ (Play)] (or [▶▶]) to skip to the next picture and continue the slide show.
 - If you press [▶▶] or [◀◀] during the slide show, it skips to the next or previous picture.



After the last picture has displayed, the thumbnail pictures appear.

- To stop the slide show, press [■]. The thumbnail pictures appear on the TV screen.
- If [DVD MENU] while holding [SHIFT] down is pressed during the slide show, the thumbnail pictures appear.

Notes:

- FUJICOLOR CD can be used.
- Some discs cannot be played back depending on the recording conditions.
- MP3 or WMA file on the KODAK Picture CD is not recognized on this unit.



JPEG CD Playback

You can also view digital images from JPEG files on disc created by your computer.

- It would take 30 seconds or more for this unit to read the JPEG files depending on its structure.
- Some JPEG files cannot be played back depending on the recording conditions.

To play the picture one by one

1. Load the disc with the label facing up on the disc tray. (Please refer to "MP3/WMA CD OPERATION" on page E50.)
 - The number of all files on the disc appears on the FL display.
 - The file list appears on the TV screen.

Example:

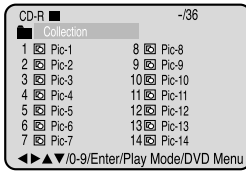

- If you press [DVD MENU] while holding [SHIFT] down, the thumbnail pictures appear.

2. Press [◀] or [▶] or [ENTER] to select folder.
3. Press [▲], [▼], [◀], [▶] or number buttons [0–9] to select your desired file.
 - In case the folder include more than 15 files, press [◀] or [▶] to display next file list.
4. Press [ENTER] to play the selected picture.
 - **Selecting a picture from the thumbnail pictures**
 - 1) Press [DVD MENU] while holding [SHIFT] down, the thumbnail pictures appear.

Example:

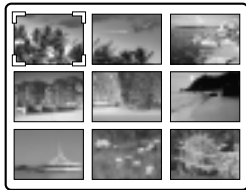

- If you press [TOP MENU] while holding [SHIFT] down, the file list appears.

- 2) Press [▲], [▶], [▼] or [◀] to move the cursor to the desired picture.
 - To go to the next or previous thumbnail pictures, press [▶▶] or [◀◀].
- 3) Press [ENTER] (or [▶ (Play)]) to play the selected picture.
 - **If the picture appears upside down or sideways...** Press [ANGLE] repeatedly while holding [SHIFT] down until it's right side up. "⏪", "⏩", "⏴" or "⏵" appears briefly on the TV screen.
 - Press [▶▶] or [◀◀] to skip to the next or previous picture.
 - To stop the playback, press [■]. The file list appears.

Note:

If the disc is loaded with the label side downward, or if a badly scratched disc is loaded, "Err (Error)" appears on the FL display and "Incorrect Disc" appears on the TV screen. If this occurs, load the disc correctly or replace the disc.

Picture Zoom

Please see page E45.

Important Note:

"⏸" may appear on the TV screen during operation. This icon means that the function is not available on the disc now.

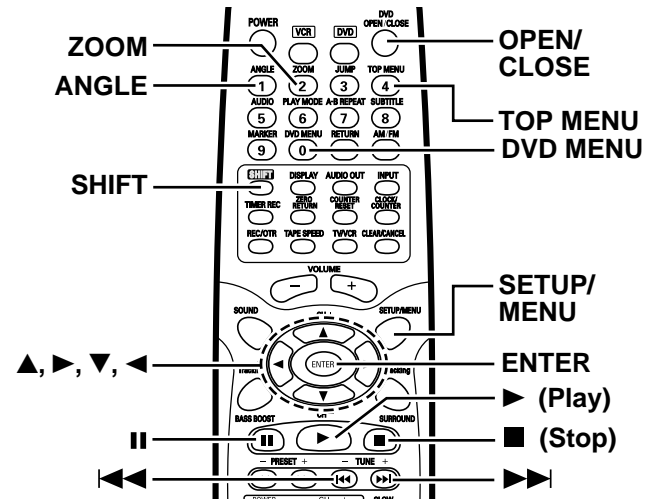

To start the slide show

Preparation:

1. If the disc loaded, remove the disc first.
2. Set "JPEG Interval" setting to "5 Seconds", "10 Seconds" or "15 Seconds" (see page E57).

1. Load the disc with the label facing up on the disc tray. (Please refer to "MP3/WMA CD OPERATION" on page E50.)
 - The file list appears on the TV screen.
2. Press [◀] or [▶] or [ENTER] to select folder.
3. Press [▲], [▼], [◀], [▶] or number buttons [0–9] to select your desired file.
 - In case the folder include more than 15 files, press [◀] or [▶] to display next file list.
 - You can also select the desired picture from the thumbnail pictures. See "Selecting a picture from the thumbnail pictures" as left described.
4. Press [ENTER] to start slide show from the selected file.
 - If you press [⏪] during the slide show, the slide show stops temporary. "⏪" appears briefly on the picture. Press [▶ (Play)] (or [▶▶]) again to resume the slide show.
 - **If the picture appears upside down or sideways, please do the following steps.**
 - 1) Press [⏪], if necessary.
 - 2) Press [ANGLE] repeatedly while holding [SHIFT] down until it's right side up. "⏪", "⏩", "⏴" or "⏵" appears briefly on the TV screen.
 - 3) Press [▶ (Play)] (or [▶▶]) to skip to the next picture and continue the slide show.
 - If you press [▶▶] or [◀◀] during the slide show, it skips to the next or previous picture.



After the last picture has displayed, the file list appears.

- To stop the slide show, press [■]. The file list appears.
- If [DVD MENU] while holding [SHIFT] down is pressed during the slide show, the thumbnail pictures appear.

If the disc is mixed with MP3, WMA and JPEG files...

1. Press [▲], [▶], [▼] or [◀] to move the highlighted box to the desired file.
2. Press [ENTER] to start playback (or slide show).
 - If you start from the MP3 or WMA file, the unit plays both MP3 and WMA files. But the unit skips the JPEG files automatically.
 - If you start from the JPEG file, the unit plays the JPEG files. But the unit skips both MP3 and WMA files automatically.
 - If you want to display only MP3/WMA or JPEG file, you need to set "Select Files" on page E57.

TVGuardian® OPERATION

TVGuardian® Technology embedded into the main unit will filter foul language from pre-recorded movies which have CC (Closed Caption). Words detected by TVG® will be muted from the program audio channel, and a version of the phrase, with the foul language converted to a suitable replacement word, can be displayed on the TV screen.

This is accomplished by a process which:

- reads the hidden signals for closed captions,
- detects offensive language,
- momentarily mutes the sound, and
- displays acceptable words and phrases.

Important Information:

The built-in TVGuardian® Foul Language Filter (TVG®) works only English language DVD video disc and video cassette tape supporting closed caption, not any other languages.

Set the TVG MODE to ON Mode (TOLERANT, MODERATE, STRICT)

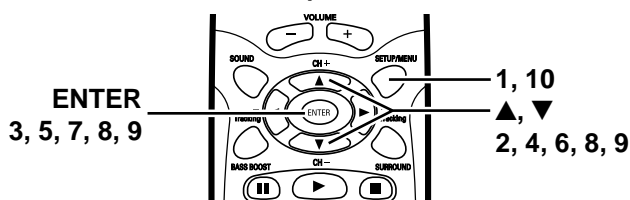

1. Press [SETUP/MENU] repeatedly until the "MENU" screen appears on the TV screen.

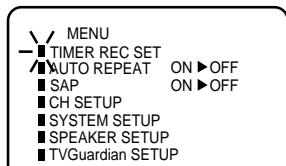

2. Press [▲] or [▼] to select "TVGuardian SETUP".

3. Press [ENTER].

The "TVGuardian SETUP" screen appears on the TV screen.

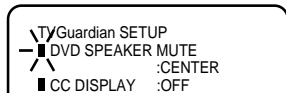

4. Press [▼] or [▲] to select "TVG MODE".

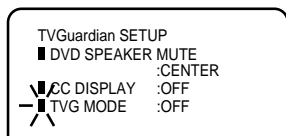

5. Press [ENTER]. "OFF" blinks.

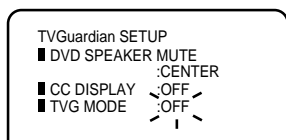

6. Press [▼] or [▲] to select the setting option. If "TOLERANT", "MODERATE" or "STRICT" is selected, word setting option menu appears.

OFF:

In the OFF mode, TVG will not operate. Your unit will operate as normal.

TOLERANT:

In the Tolerant mode, only the most offensive foul language will be filtered.

MODERATE:

In the Moderate mode, more offensive words will be filtered.

STRICT:

In the Strict mode, all the foul language words known to the TVG process will be filtered.

7. Press [ENTER].

Notes:

- If TVG MODE is not necessary, select "OFF".
- When shipped from factory, the TVG MODE option is set to "OFF" position.

8. TVG WORD Settings

In addition to the main TVG modes, three additional sets of words are available to the user to selectively turn on or off. On means that the words belonging to the set will be filtered. Off means that they will not be affected by the TVG processing.

Press [▼] or [▲] to select a desired option (DAMN AND HELL, RELIGIOUS or SEXUAL REFERENCE), then press [ENTER].

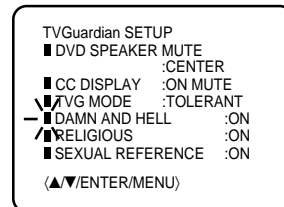

DAMN AND HELL:

This set includes variations of "Damn" and "Hell".

RELIGIOUS:

This set includes numerous Religious words, such as God and Jesus. One might want to turn this Word Set to Off if watching religious programming material.

SEXUAL REFERENCE:

This set includes various sexually related words.

9. Press [▼] or [▲] to select "ON" or "OFF", then press [ENTER].

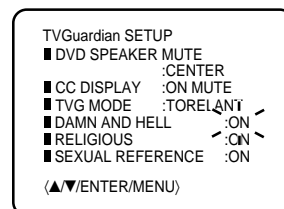

10. Press [SETUP/MENU] until the menu screen is cleared.

Notes:

- When the user changes from any TVG On mode (Tolerant, Moderate or Strict) to the Off mode, all the word sets are turned Off. Whenever you change from the TVG Off mode to any three On modes, all three of these word sets are changed to On setting.
- When shipped from factory, the TVG WORD option is set to "ON" position.
- You can not select the subtitle language when the TVG MODE option is set to "ON" position.

TVGuardian® and TVG® are registered trademarks of Principle Solutions, Inc.



DVD SPEAKER MUTE Setting

1. Press [SETUP/MENU] repeatedly until the "MENU" screen appears on the TV screen.

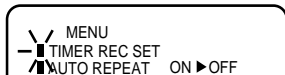

2. Press [▼] or [▲] to select "TVGuardian SETUP", then press [ENTER].
3. Press [▲] or [▼] to select "DVD SPEAKER MUTE", then press [ENTER].

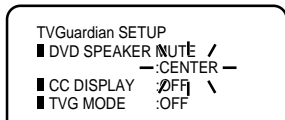

4. Press [▼] or [▲] to select the setting option, then press [ENTER].

CENTER:

If the TVG MODE is On mode, mute the sound of center speaker while DVD is playing.

ALL:

If the TVG MODE is On mode, mute the sound of all speakers while DVD is playing.

5. Press [SETUP/MENU] until the menu screen is cleared.

Note:

When shipped from factory, the DVD SPEAKER MUTE option is set to "CENTER" position.

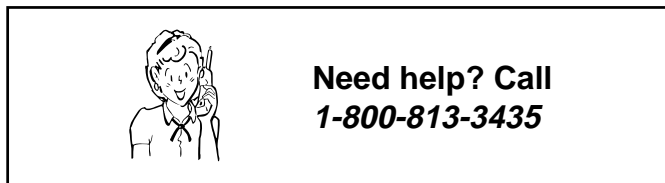
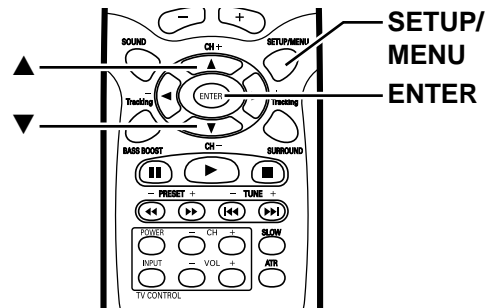

CC (Closed Caption) DISPLAY Setting with TVG MODE is Set to ON Mode

1. Press [SETUP/MENU] repeatedly until the "MENU" screen appears on the TV screen.

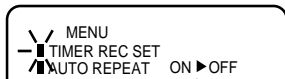

2. Press [▲] or [▼] to select "TVGuardian SETUP", then press [ENTER].
3. Press [▲] or [▼] to select "CC DISPLAY", then press [ENTER].
4. Press [▼] or [▲] to select the setting option, then press [ENTER].



ON MUTE:

Whenever Foul Language is detected, captions are displayed with a suitable replacement word substituted for the foul language, and audio is muted for the foul language.

CONTINUOUS:

You can see all captions, whether or not any foul language was detected. But like the ON MUTE mode, captions are displayed with a suitable replacement word substituted for the foul language, and audio is muted for the foul language.

OFF:

You cannot see captions. Whenever Foul language is detected, only audio is muted.

5. Press [SETUP/MENU] until the menu screen is cleared.

CC (Closed Caption) DISPLAY Setting with TVG MODE is Set to OFF Mode

1. Press [SETUP/MENU] repeatedly until the "MENU" screen appears on the TV screen.

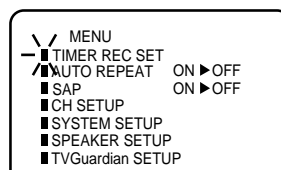

2. Press [▲] or [▼] to select "TVGuardian SETUP", then press [ENTER].
3. Press [▲] or [▼] to select "CC DISPLAY", then press [ENTER].
4. Press [▼] or [▲] to select the setting option, then press [ENTER].

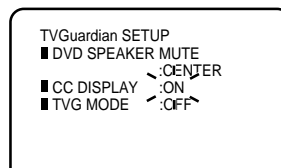

ON: You can see all captions.

OFF: You cannot see captions.

5. Press [SETUP/MENU] until the menu screen is cleared.

Notes:

- When playback starts, the TVG information may appear on the TV screen (TVG or NO TVG).
- Although the CC DISPLAY is set to "OFF", the closed caption may appear on the TV screen according to a TV with closed caption capability.

INITIAL SETTINGS

Once the initial settings have been completed, the unit can always be operated under the same conditions. The settings will be retained in the memory until they are changed, even if the power is turned off.

Setting Language

1. Press [SETUP/MENU] in the stop mode or No Disc. The setup screen appears.

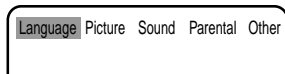

2. Press [▼] or [ENTER]. The "Language" screen appears.

3. Press [▲] or [▼] to select the item. Example:

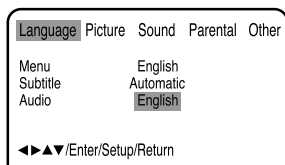

4. Press [▶] or [ENTER]. The submenu appears.
5. Press [▲] or [▼] to select your desired language. Example:

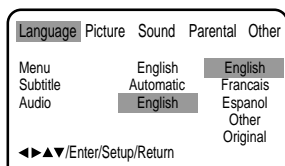

6. Press [ENTER]. The selected language remains.
7. Repeat steps 3 ~ 6 for other setting.
English, Francais, Espanol: The language you have selected will play if it is recorded on the disc.

Other:

If you want to select another language, enter the language code. (See the language code list on page E60.)

Original:

The unit will select the first priority language of each disc.

Automatic:

- The unit will automatically select the same language in the AUDIO setting.
- When the unit selects the same language as the AUDIO, the subtitles will not appear during playback.
- When you do not use the same language as the AUDIO, the subtitles will appear during playback.

Off:

Subtitles do not appear.

8. Press [SETUP/MENU] or [RETURN] to close the screen.

Notes:

- In this instruction manual, the language in on-screen display is English. If you change the language, please follow the selected language in on-screen display.
- You cannot switch audio sound track languages if there is only one language recorded on the disc.
- When you play back a DVD video disc, the unit automatically displays the pre-selected subtitle language if it is included on the disc.
- If "Other" is selected, enter the language code. (See "LANGUAGE CODE LIST" on page E60.)

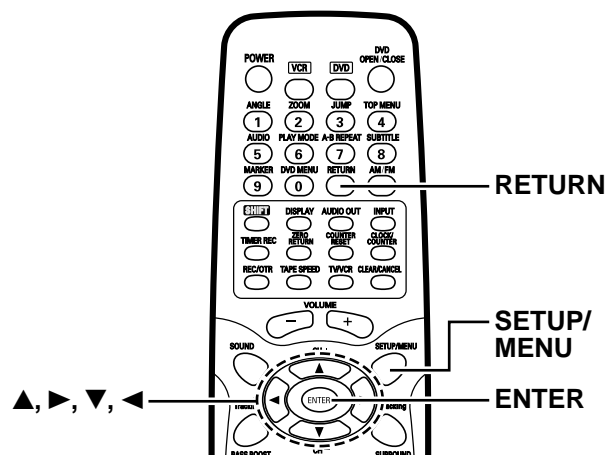

Setting OSD Language

1. Press [SETUP/MENU] in the stop mode or No Disc. The setup screen appears.

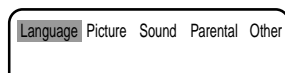

2. Press [▶] to select "Other".

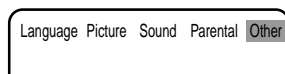

3. Press [▼] or [ENTER]. The "OSD Language" screen appears.

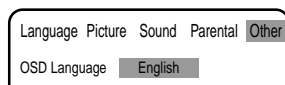

4. Press [▶] or [ENTER]. The submenu appears.

5. Press [▲] or [▼] to select your desired language. Example:

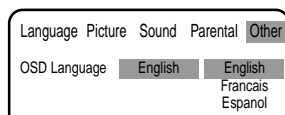

6. Press [ENTER]. The language remains. (The OSD Language is changed.)
7. Press [SETUP/MENU] or [RETURN] to close the screen.



Setting Picture

1. Press [SETUP/MENU] in the stop mode or No disc. The setup screen appears.

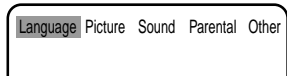

2. Press [▶] to select "Picture".
3. Press [▼] or [ENTER]. The Picture screen ("Tv Screen", "Display", "JPEG Interval" and "Select Files") appears. "Tv Screen" is selected.
4. Press [▶] or [ENTER]. The submenu appears.
5. Press [▲] or [▼] to select your desired screen type.

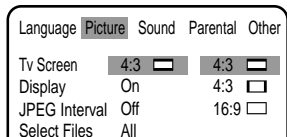

6. Press [ENTER]. The TV screen size is set.

4:3 (Letterbox):

Select when a conventional TV set is connected.

When the wide screen disc is played back, the black bands appear at the top and bottom of screen.



4:3 (Panscan):

Select when a conventional TV set is connected.

When the wide screen disc is played back, it displays pictures cropped to fill to your TV screen. The left and right edges are cut off.

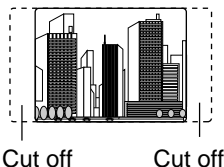

16:9 (Wide screen):

Select when a wide screen TV set is connected.

Played in "FULL" size. (Setting the wide screen TV to "FULL" mode is also necessary.)

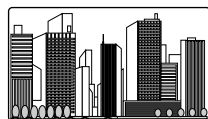

Notes:

- The screen size may differ depending on the DVD video discs.
- If you select 16:9 to get rid of the black bands on screen when wide screen disc is played back, picture may be slightly distorted.
- In some discs, even if 4:3 is selected, the black bands may remain on the screen.

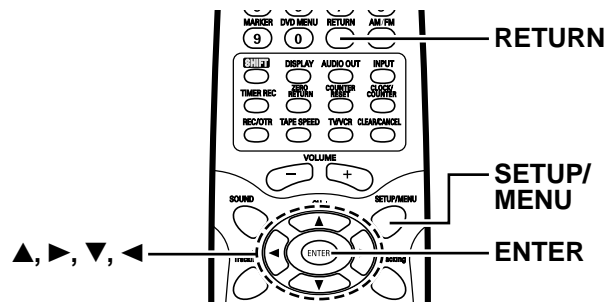

7. Press [▼] to select "Display".
8. Press [▶] or [ENTER] to select "On" or "Off".

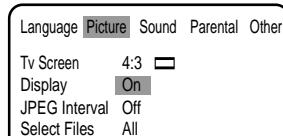

On: On-screen displays appear when you press the buttons.

Off: On-screen displays do not appear when you press any buttons.

9. Press [▼] to select "JPEG Interval".
10. Press [▶] or [ENTER] to select your desired time.

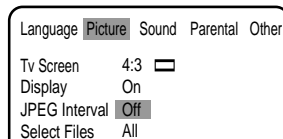

Off:

Plays back one file at a time.

5 Seconds:

Plays back images in the form of a slide show at 5-second intervals.

10 Seconds:

Plays back images in the form of a slide show at 10-second intervals.

15 Seconds:

Plays back images in the form of a slide show in 15-second intervals.

11. Press or [▼] to select "Select Files".
12. Press [▶] or [ENTER] to select your desired file type.

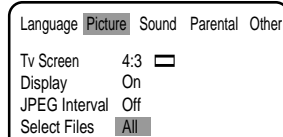

All:

Displays all files on the file menu.

Music Only:

Displays only MP3/WMA files on the file menu.

Pictures Only:

Displays only JPEG/KODAK Picture CD/FUJICOLOR CD files on the file menu.

Note: Usually set to "All".

13. Press [SETUP/MENU] or [RETURN] to close the screen.

Setting Sound

Used to adjust the sound level between the powerful sound and the faint sound.

1. Press [SETUP/MENU] in the stop mode or No disc.
The setup screen appears.

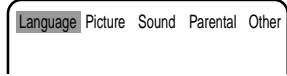

2. Press [▶] to select "Sound".
3. Press [▼] or [ENTER].
The Sound screen (DRC) appears.
(DRC: Dynamic Range Control)
4. Press [▶] or [ENTER].
The submenu ("Std" and "TV") appears.
5. Press [▲] or [▼] to select your desired sound type.

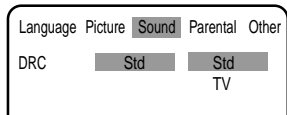

Std: Normally set to this position.

TV: When listen to the DVD disc sound using TV's speaker (connecting the 75 ohm coaxial cable, see page E10), select this submenu "TV".

6. Press [ENTER].
7. Press [SETUP/MENU] or [RETURN] to close the screen.

Notes:

- The DRC function works only during playback of Dolby Digital recorded discs.
- The level of DRC may differ depending on the DVD video disc.

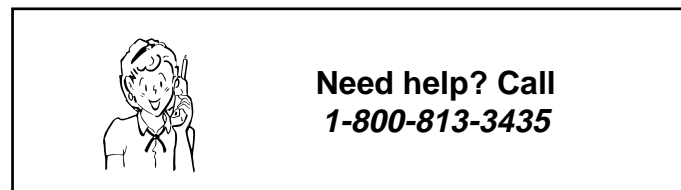
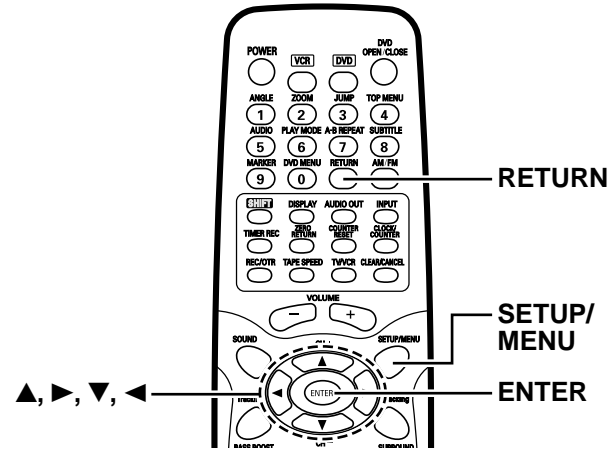

Setting Parental

Some discs are specified not suitable for children. Such discs can be limited not to play back with the unit.

1. Press [SETUP/MENU] in the stop mode or No disc. The setup screen appears.

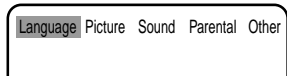

2. Press [▶] to select "Parental".
3. Press [▼] or [ENTER]. The Parental screen ("Password" and "Parental") appears.

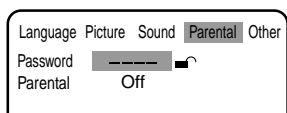

4. Press [▼] to skip "Password" and select "Parental".
5. Press [◀] or [▶] repeatedly to select the level (1 ~ 8) or "Off". Example:

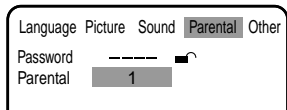

6. Press [▲] to select "Password".
7. Press the number buttons [0-9] to input a 4-digit password. Be sure to remember this number! If you input a wrong number, press [CLEAR/CANCEL].
8. Press [ENTER]. Example:

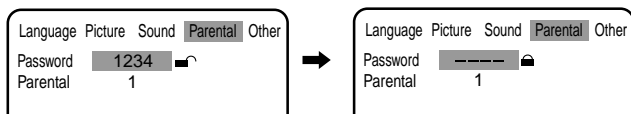

9. Press [SETUP/MENU] or [RETURN] to close the screen.

To Change the Parental Level

1. Repeat the steps 1 ~ 3 as above to open the Parental screen.
2. Press the number buttons [0-9] to enter the password you have stored.
3. Press [ENTER]. The rating is now unlocked.
4. Press [▼] to select "Parental", then press [◀] or [▶] to change the parental level.
5. Press [▲] to select "Password". Press the number buttons [0-9] to enter the password. Note: You can change the password if you want.
6. Press [ENTER]. Now the parental level is changed and locked.
7. Press [SETUP/MENU] or [RETURN] to close the screen.

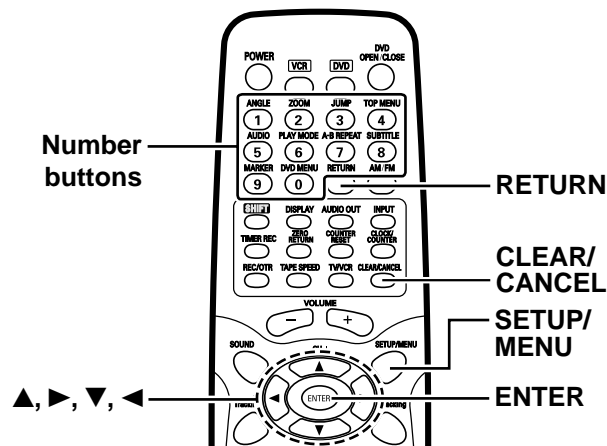

Parental Control

MPAA (Motion Picture Association of America) Guideline is a rating system that provides advanced cautionary information to parent about the content of movie programs.

The parental lock level is equivalent to the following MPAA Rating System.

- Level 7: NC-17 (No one 17 and under admitted)
- Level 6: R (Restricted)
- Level 4: PG-13 (Parents strongly cautioned)
- Level 3: PG (Parental guidance suggested)
- Level 1: G (General audiences)

Some DVD discs contain a restriction level which enables parents to prevent playback of discs by children. This unit is equipped with a password designed to prevent children changing the level.

You cannot play DVD video discs rated higher than the level you selected unless you cancel the parental lock function. For example, when you select level "5", the unit will not play discs with ratings of "6", "7" or "8". The information will appear on the TV screen. When you select level "Off", all DVD video discs can be played back.

If you forget the password...

1. Press [OPEN/CLOSE] to open the disc tray.
2. Remove the disc.
3. Press [OPEN/CLOSE] again to close the tray. "No Disc" appears on the TV screen.
4. While holding [■ STOP] down on the front panel, press [7] on the remote control for 3 seconds. "PASSWORD CLEAR" appears on the TV screen.
5. Enter a new password again.

Note:
DVD video discs may or may not respond to the parental lock settings. Make sure this function works with your DVD video discs.



**Need help? Call
1-800-813-3435**

LANGUAGE CODE LIST

Enter the appropriate code number for the initial settings "Menu", "Subtitle" and "Audio" language on page E56".

Language Name Code	Language Name Code	Language Name Code	Language Name Code
Abkhazian 1112	Fiji 1620	Lingala 2224	Singhalese 2919
Afar 1111	Finnish 1619	Lithuanian 2230	Slovak 2921
Afrikaans 1116	French 1628	Macedonian 2321	Slovenian 2922
Albanian 2927	Frisian 1635	Malagasy 2317	Somali 2925
Amharic 1123	Galician 1722	Malay 2329	Spanish 1529
Arabic 1128	Georgian 2111	Malayalam 2322	Sundanese 2931
Armenian 1835	German 1415	Maltese 2330	Swahili 2933
Assamese 1129	Greek 1522	Maori 2319	Swedish 2932
Aymara 1135	Greenlandic 2122	Marathi 2328	Tagalog 3022
Azerbaijani 1136	Guarani 1724	Moldavian 2325	Tajik 3017
Bashkir 1211	Gujarati 1731	Mongolian 2324	Tamil 3011
Basque 1531	Hausa 1811	Nauru 2411	Tatar 3030
Bengali; Bangla 1224	Hebrew 1933	Nepali 2415	Telugu 3015
Bhutani 1436	Hindi 1819	Norwegian 2425	Thai 3018
Bihari 1218	Hungarian 1831	Oriya 2528	Tibetan 1225
Breton 1228	Icelandic 1929	Panjabi 2611	Tigrinya 3019
Bulgarian 1217	Indonesian 1924	Pashto, Pushto 2629	Tonga 3025
Burmese 2335	Interlingua 1911	Persian 1611	Turkish 3028
Byelorussian 1215	Irish 1711	Polish 2622	Turkmen 3021
Cambodian 2123	Italian 1930	Portuguese 2630	Twi 3033
Catalan 1311	Japanese 2011	Quechua 2731	Ukrainian 3121
Chinese 3618	Javanese 2033	Rhaeto-Romance 2823	Urdu 3128
Corsican 1325	Kannada 2124	Romanian 2825	Uzbek 3136
Croatian 1828	Kashmiri 2129	Russian 2831	Vietnamese 3219
Czech 1329	Kazakh 2121	Samoan 2923	Volapük 3225
Danish 1411	Kirghiz 2135	Sanskrit 2911	Welsh 1335
Dutch 2422	Korean 2125	Scots Gaelic 1714	Wolof 3325
English 1524	Kurdish 2131	Serbian 2928	Xhosa 3418
Esperanto 1525	Laothian 2225	Serbo-Croatian 2918	Yiddish 2019
Estonian 1530	Latin 2211	Shona 2924	Yoruba 3525
Faroese 1625	Latvian, Lettish 2232	Sindhi 2914	Zulu 3631

LISTENING TO THE RADIO

Preparation:

Press [POWER] to turn on the unit.

Automatic/Manual Tuning

1. Press [AM/FM] to select FM or AM.

2. Automatic tuning

Press [TUNE] + or – for at least 1 second to tune in a station. The unit will scan up or down the band and receive the next receivable station. Press the button again to continue.

Manual tuning

Press [TUNE] + or – briefly until the desired frequency is displayed. The frequency changes in 200 kHz steps for FM and 10 kHz steps for AM.

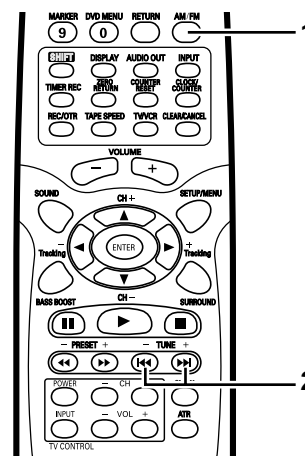
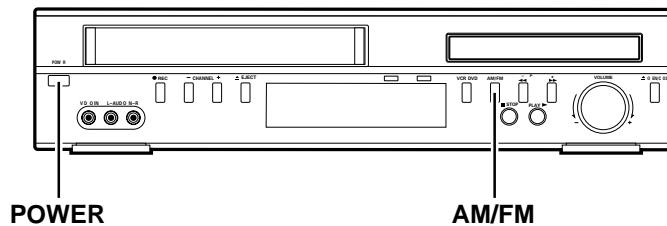
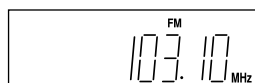

To Preset Stations

Up to 24 FM and 12 AM stations can be preset.

Automatic presetting (APT)

1. Press [AM/FM].

2. Press [SETUP/MENU] for at least 3 seconds.

“–” and “FM (and AM)” blink.

The automatic tuning mode is set and automatic presetting begins from the low end of the FM band to the AM band.

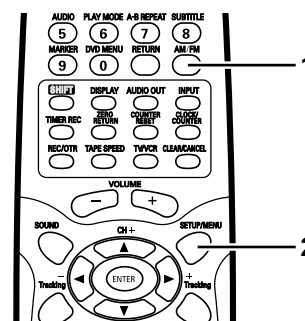
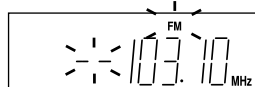

When 24 FM or 12 AM stations have been preset or the high end of the band is reached, automatic presetting stops.

“–” disappears and the station memorized on channel 1 will be heard.

Note:

If APT is activated, all previously programmed stations of the band will be cleared and new stations will be programmed.



**Need help? Call
1-800-813-3435**

Manual presetting

1. Press [AM/FM] to select FM or AM.
2. Tune in the station to be preset as described in "Automatic/Manual Tuning".
3. Press [SETUP/MENU].
"Preset number" blinks.

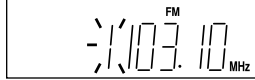

4. While "preset number" is blinking, press [PRESET] + or - to select the channel to be preset.
 - The number buttons on the remote control can also be used.
 - In this example, the channel is "9".



5. While "preset number" is blinking, press [ENTER].
"Preset number" blinking stops.
6. Press [SETUP/MENU].
"Preset number" disappears.
 - In this example, "103.1 MHz" FM station is preset on FM channel 9.

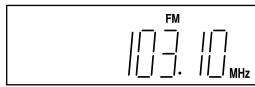

7. Repeat steps above to add more preset stations.
 - When presetting a new station, the previous preset station is cleared.

Listening to Preset Stations

1. Press [AM/FM] to select FM or AM.
2. Press [PRESET] + or - briefly to select the desired channel.
 - If using the number buttons, press the number button(s), then press [ENTER].

Example:

To select preset number 3, press [0] [3], then [ENTER].
To select preset number 12, press [1] [2], then [ENTER].

Note:

Usually, when receiving the FM stereo broadcast you enjoy FM stereo sound, if the signal from the station becomes weak, the tuner automatically sets to monaural reception.

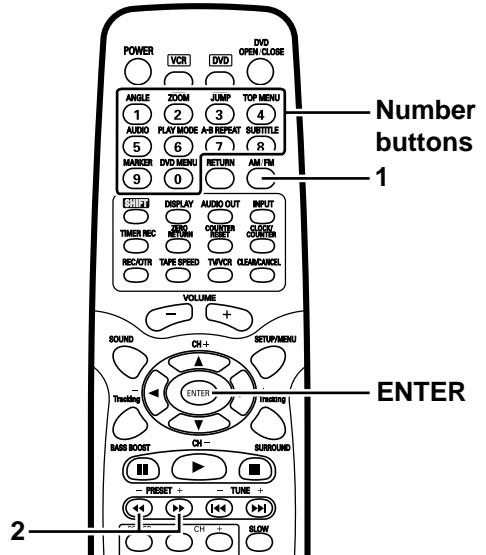
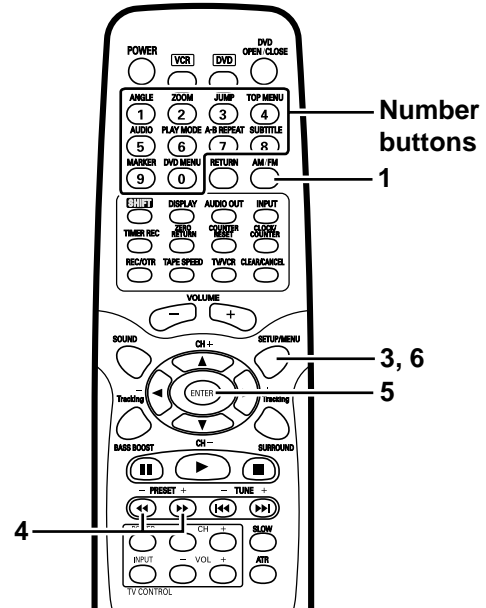
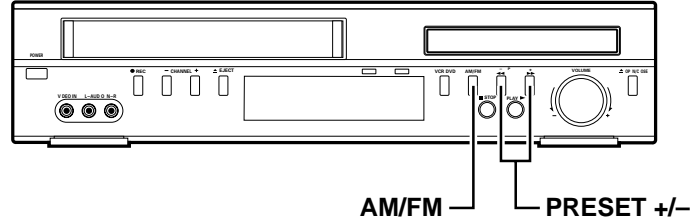

TROUBLESHOOTING GUIDE

If you have followed the instructions and are having difficulty operation the unit, locate the SYMPTOM in the left column below. Check the corresponding POSSIBLE CAUSE and CORRECTIVE ACTION columns to locate and remedy the problem.

SYMPTOM	POSSIBLE CAUSE	CORRECTIVE ACTION
No power.	<ul style="list-style-type: none"> The power cord is disconnected. 	<ul style="list-style-type: none"> Plug the power cord into the wall outlet securely.
The power is on, but the DVD/VCR does not work.	<ul style="list-style-type: none"> No tape is inserted. No disc is inserted. 	<ul style="list-style-type: none"> Insert a tape or disc. (See page E27 or E39)
No picture.	<ul style="list-style-type: none"> The video channel of the TV is not set to channel 3 or 4. 	<ul style="list-style-type: none"> Set the TV's video channel to 3 or 4.
	<ul style="list-style-type: none"> The TV is not set to receive DVD/VCR signal output. 	<ul style="list-style-type: none"> Select the appropriate video input mode on the TV so the picture from the DVD/VCR appears on the TV screen.
	<ul style="list-style-type: none"> TV/VCR mode for DVD/VCR is set to TV. 	<ul style="list-style-type: none"> Press [TV/VCR] on the remote control repeatedly to choose VCR mode. "VCR" appears on the FL display.
	<ul style="list-style-type: none"> The video cable is not connected securely. 	<ul style="list-style-type: none"> Connect the video cable securely.
	<ul style="list-style-type: none"> The video cable or 75 ohm coaxial cable is not connected. 	<ul style="list-style-type: none"> Connect the video cable into the jack. (See page E10.) Connect the 75 ohm coaxial cable into the jack. (See page E10.)
	<ul style="list-style-type: none"> Video connection is not correct. Note: S-Video/component out does not output the VCR/tuner video signal. They are only for DVD video output. 	<ul style="list-style-type: none"> Connect the cord correctly. See "Basic TV Connections" or "Audio/Video Connection" on page E10.
	<ul style="list-style-type: none"> The connected TV power is turned off. An unplayable disc is loaded. 	<ul style="list-style-type: none"> Turn on the TV. Load a playable disc. (Check the disc logo, type, color system and regional code.) (See page E38.)
No sound.	<ul style="list-style-type: none"> The audio cables are not connected securely. 	<ul style="list-style-type: none"> Connect the audio cable securely.
	<ul style="list-style-type: none"> The wrong function is selected. 	<ul style="list-style-type: none"> Select the correct function. (See page E20.)
	<ul style="list-style-type: none"> Faulty speaker connections. 	<ul style="list-style-type: none"> Connect the speaker wires firmly to the speaker terminals. (See page E14.)
	<ul style="list-style-type: none"> Volume control is set to minimum. 	<ul style="list-style-type: none"> Turn up the volume.
Sound is heard from only one speaker.	<ul style="list-style-type: none"> Faulty speaker connections. 	<ul style="list-style-type: none"> Connect the speaker wires firmly to the speaker terminals. (See page E14.)
The playback picture is poor.	<ul style="list-style-type: none"> The disc is dirty. 	<ul style="list-style-type: none"> Clean the disc. (See page E38.)
	<ul style="list-style-type: none"> Tape heads are dirty. 	<ul style="list-style-type: none"> Clean video heads. (See page E65.)
	<ul style="list-style-type: none"> Tape is a rental or was recorded on another VCR. 	<ul style="list-style-type: none"> Use [Tracking] +/- for manual tracking adjustment while tape is playing. (See page E29.)
	<ul style="list-style-type: none"> An unplayable disc is loaded. 	<ul style="list-style-type: none"> Load a playable disc. (Check the disc logo, type, color system and regional code.) (See page E38.)
The DVD/VCR does not start playback.	<ul style="list-style-type: none"> No tape is inserted. No disc is inserted. 	<ul style="list-style-type: none"> Insert a tape or disc. (See page E27 or E39.)
	<ul style="list-style-type: none"> An unplayable disc is inserted. 	<ul style="list-style-type: none"> Load a playable disc. (Check the disc type, color system, and regional code.) (See page E38.)
	<ul style="list-style-type: none"> The disc is placed upside down. 	<ul style="list-style-type: none"> Place the disc with the playback side down.
	<ul style="list-style-type: none"> The disc is not placed within the guide. 	<ul style="list-style-type: none"> Place the disc on the disc tray correctly inside the guide.
	<ul style="list-style-type: none"> The disc is dirty. 	<ul style="list-style-type: none"> Clean the disc. (See page E38.)
	<ul style="list-style-type: none"> "PARENTAL" is set. 	<ul style="list-style-type: none"> Cancel the parental lock function or change the rating level. Reset it after play. (See page E59.)
On music CD - sound only comes from front left and right speakers. No sound from rear and center speakers.	<ul style="list-style-type: none"> Unit automatically sets 2.1 channel (Front left and right speakers, and Subwoofer). 	<ul style="list-style-type: none"> Press [SURROUND] repeatedly to select "Surr", "HALL" or "LIVE". (See page E21.)



SYMPTOM	POSSIBLE CAUSE	CORRECTIVE ACTION
The remote control does not work properly.	• The remote control is not pointed at the remote sensor of the main unit.	• Point the remote control at the remote sensor of the main unit. (See page E8.)
	• The remote control is too far from the main unit.	• Operate the remote control within 23 feet (7 meters).
	• There is an obstacle in the path of the remote control and the main unit.	• Remove the obstacle.
	• The batteries in the remote control are weak, or installed incorrectly.	• Check the battery polarity (+ or -). (See page E8.) • Replace the batteries. (See page E8.)
	• This remote control use the same buttons for VCR and DVD functions (ex. PLAY (▶)).	• When using a VCR, first press the [VCR] button. When using a DVD, first press the [DVD] button.
“  ” appears on the TV screen.	• The selected function does not operate on the disc now.	• The feature or action cannot be completed at this time because: • The feature is not available at the moment. • The DVD software restricts it. • The DVD software doesn't support the feature (e.g., angles).
Some channels are skipped over when using [CH] +/-.	• Those channels were deleted with the ADD/DELETE option.	• Use ADD/DELETE to restore channels. See “To ADD/DELETE Channels” on page E26.
Picture and sound of broadcasting channel are weak or missing.	• Antenna or cables are loose.	• Tighten connections or replace cable.
	• Wrong TV/CATV option is being used.	• See “TV/CATV selection” on page E25 for details.
The conversation in DVD programs is hard to listen to.	• Center speaker level is low.	• Raise the center speaker level. (See page E20 or E22.)
Cannot play MP3/WMA CD or Picture CD.	• The first file playback is not unwanted one on a CD containing a mixture of MP3, WMA and JPEG files.	• Select MP3/WMA file or JPEG file on the file list you want to play. (See page E53.)
	• “Select Files” setting is not correct.	• Set “Select Files” setting correctly. (See page E57.)
Camcorder image is not shown.	• Camcorder is off.	• Turn camcorder on and operate properly.
Camcorder image via AUDIO/VIDEO input to the unit is not shown on TV screen.	• AUDIO/VIDEO input is not selected.	• Press [INPUT] to select AUDIO/VIDEO input position. (See page E37.)
Timer recording is not possible.	• Clock in the unit is not set to correct time.	• Set clock to correct time. See “Manual Clock Setting” on page E19.
	• The unit is on which disables timer.	• Press [TIMER REC] to enable timer. Timer recording indicator appears on the FL display.
	• Timer has been programmed incorrectly.	• Reprogram timer. See “Timer Recording” on pages E34 and E35.
	• Timer recording indicator does not appear after programming timer.	• Reprogram timer and turn the unit off to enable timer.
Timer recording indicator appears during the unit is turned off.	• The unit is in timer recording mode.	• This is the normal indication that the the unit is in timer mode.
The operation or display is not normal.	• The unit must be reset.	1. Disconnect the power cord. (See page E5.) 2. Reconnect the power cord. 3. Resume operation.

SERVICING:

Should this product require service, refer to the SANYO AUDIO/VIDEO limited warranty.

If you do not have a convenient SANYO service station nearby, contact the SANYO dealer where you purchased the unit. Be sure to give the model number and explain the problem. The dealer will advise you how to obtain service.





MAINTENANCE

WARNING:

FOR YOUR PERSONAL SAFETY, BE SURE TO DISCONNECT THE AC POWER CORD BEFORE PROCEEDING WITH ANY MAINTENANCE OR CLEANING.

Cleaning the Cabinet

Use a clean soft cloth moistened with plain lukewarm water and wrung dry. Never use benzol, benzene or other strong chemical cleaners since these could damage the finish of your unit. It is important that no liquid reaches the inside of the unit.

Video Head Cleaning

Video head clogging

The video heads are the means by which the unit reads the picture from the tape during playback. In the unlikely event that the heads become dirty enough to be clogged, no picture will be played back. This can easily be determined if, during playback of a known good tape, there is good sound, but no picture (picture is extremely snowy). If this is the case, use a high quality head cleaning system or have them cleaned professionally.



Good Picture



Snowy Picture

Video head cleaning

Video head cleaning is needed when the playback picture becomes unclear. This signifies that the heads are getting dirty and can occur when playing poor quality or damaged tapes. If the heads require cleaning, use a equivalent high quality chemical non-abrasive (wet) head cleaning tape or have them cleaned professionally. If playing a head cleaning tape in the unit once does not improve the picture, play it several times before requesting service.

Notes:

- DO NOT ATTEMPT TO CLEAN THE VIDEO HEADS OR SERVICE THE UNIT BY REMOVING THE TOP COVER.
- Video heads may eventually wear out and should be replaced when they fail to produce clear pictures.
- To help prevent video head clogging, use only good quality VHS tapes. Discard worn out tapes.

SPECIFICATIONS

General

Power requirements:
AC 120V, 60Hz
Power consumption:
23 Watts
Dimensions (W x H x D):
Approx. 16.9" x 3.9" x 12.5" (430 x 99 x 318 mm)
Weight:
Approx. 10.4 lbs (4.7 kg)
Operating temperature:
5°C to 40°C (41°F to 104°F)
Operating humidity:
Less than 80 % RH
Color signal system:
NTSC

VCR Section

Head system:
Four head helical scan azimuth system
Timer:
12-hour display type with AM, PM
Tape speed
SP: 33.35 mm/sec, LP: 16.67 mm/sec, SLP: 11.12 mm/sec
Tape width:
1/2 inch (12.7 mm)
Maximum recording time:
SP: 2 hours (T-120), SLP: 6 hours (T-120)
FF/REW time at 25°C (77°F):
Approx. 1 minute and 48 seconds
Antenna:
75 ohms (VHF/UHF)
VHF output signal:
Channel 3 or 4 (Switchable)
Channel coverage:
VHF: 2 – 13
UHF: 14 – 69, CATV: 1 – 125 (4A, A-W, W+1 – W+84, A-5 – A-1)
Frequency range:
20 Hz to 20 kHz (Hi-Fi), 100 Hz to 10 kHz (mono at SP)
Signal to noise ratio:
70 dB (Hi-Fi), 42 dB (mono at SP)
Dynamic range:
More than 90 dB (Hi-Fi)
Channel separation:
More than 60 dB (Hi-Fi)

DVD Video Player Section

Laser:
Semiconductor laser, wavelength 650 nm/790 nm
Signal to noise ratio:
90 dB
Frequency response:
DVD: 4 Hz – 22 kHz
CD: 4 Hz – 20 kHz
Harmonic distortion:
0.3 % (1 kHz)
Dynamic range:
More than 90 dB

Tuner Section

(FM)
Frequency range:
87.9 MHz – 107.9 MHz (200 kHz steps)
Usable sensitivity:
15 dBf (mono)
(AM)
Frequency range:
520 kHz – 1,710 kHz (10 kHz steps)
Usable sensitivity:
500 μ V/m (AM loop antenna)

Inputs

VIDEO INPUT (RCA): 1.0 Vp-p (75 Ω)
AUDIO INPUT (RCA): –8 dB (50 k Ω)
ANTENNA INPUT: Antenna or CATV input (75 Ω)

Outputs

S-VIDEO OUT:
Y: 1.0 Vp-p (75 Ω)
C: 0.286 Vp-p (75 Ω)
COMPONENT VIDEO OUT:
Y: 1.0 Vp-p (75 Ω)
P_B: 0.7 Vp-p (75 Ω)
P_R: 0.7 Vp-p (75 Ω)
AUDIO OUT (RCA): –8 dB (1 k Ω)
VIDEO OUT (RCA): 1.0 Vp-p (75 Ω)
AUDIO OUT (6-CHANNEL):
DIN 9-pin
RF OUT: Channel 3 or 4

Powered Subwoofer (ASX-3500)

Subwoofer
Continuous minimum sine wave RMS power output into 6 ohms at 70 Hz with no more than 10 % total harmonic distortion (with the other amplifiers off) 75 Watts

Satellite Speakers (Front Left & Right, Center, Surround Left & Right)
Continuous minimum sine wave RMS power output per channel into 8 ohms at 1 kHz with no more than 10 % total harmonic distortion (with the other amplifiers off) 25 Watts

AUDIO INPUT (6-CHANNEL):

DIN 9-pin
SPEAKERS (Output):
FRONT (L/R): 8 Ω
CENTER: 8 Ω
SURROUND (L/R): 8 Ω

Power requirements:
AC 120V, 60 Hz
Power consumption:
150 Watts

Unit used:
6.5" (16 cm) diameter, Cone type
Dimensions (W x H x D):
Approx. 9.1" x 15.4" x 13.8" (230 x 390 x 350 mm)
Weight:
Approx. 22.1 lbs (10 kg)

Satellite Speaker

Front left, Front right, Center, Surround left, and Surround right speakers
(SX-TS3000S, magnetic shield)

Unit used:
3.1" (8 cm) diameter, Cone type, Full range
Maximum music power handling capacity:
50 Watts
Nominal impedance:
8 Ω
Dimensions (W x H x D):
Approx. 3.7" x 5.7" x 3.4" (95 x 145 x 85 mm)
Weight:
Approx. 1.3 lbs (0.6 kg)/speaker

IMPORTANT INFORMATION

Because its products are subject to continuous improvement, SANYO reserves the right to modify product designs and specifications without notice and without incurring any obligation.



For assistance in obtaining repairs and operational information, please contact the following Toll Free Number:

DIAL TOLL FREE: 1-800-813-3435

Weekdays: 7:30 AM - 4:00 PM Central Time

Also, you may write to SANYO Manufacturing Corporation, 3333 Sanyo Road, Forrest City, Arkansas 72335.

Limited Warranty

LABOR 1 YEAR

PARTS 1 YEAR

CARRY-IN ONLY

THIS WARRANTY IS VALID ONLY ON SANYO PRODUCTS PURCHASED FROM A WAL-MART STORE AND USED IN THE UNITED STATES OF AMERICA, EXCLUDING HAWAII AND ALL U.S. TERRITORIES AND PROTECTORATES. THIS WARRANTY APPLIES ONLY TO THE ORIGINAL RETAIL PURCHASER AND DOES NOT APPLY TO PRODUCTS USED FOR ANY INDUSTRIAL, PROFESSIONAL OR COMMERCIAL PURPOSE.

Subject to the OBLIGATIONS and EXCLUSIONS below, SANYO Manufacturing Corporation. ("SANYO") warrants this SANYO product against defects in materials and workmanship for the periods of LABOR and PARTS specified above. SANYO will repair or replace (at its option) the product and any of its parts which fail to conform to this warranty with new or refurbished products or parts. The warranty period commences on the date the product was first purchased at retail from a Wal-Mart Store.

OBLIGATIONS

In order to obtain warranty service, the product must be delivered to and picked up from a Wal-Mart Store at the original retail purchaser's expense. The original dated bill of sale, or sales slip from a Wal-Mart Store must be submitted to a Wal-Mart Store at the time warranty service is requested.

EXCLUSIONS

1. This warranty does not cover (A) the adjustment of customer-operated controls as explained in the appropriate model's instruction manual, or (B) the repair of any product whose serial number has been altered, defaced or removed.
2. This warranty shall not apply to the cabinet or cosmetic parts, broken or damaged video heads, batteries or routine maintenance.
3. This warranty does not apply to uncrating, setup, installation, removal of the product for repair or reinstallation of the product after repair.
4. This warranty does not apply to repairs or replacements necessitated by any cause beyond the control of SANYO including, but not limited to, any malfunction, defect or failure caused by or resulting from unauthorized service or parts, improper maintenance, operation contrary to furnished instructions, shipping or transit accidents, modification or repair by user or any third party, abuse, misuse, neglect, accident, incorrect line voltage, fire, flood or other Acts of God, or normal wear and tear.

The foregoing is in lieu of all other express warranties and SANYO does not assume or authorize any party to assume for it any other obligation or liability.

THE DURATION OF ANY WARRANTIES WHICH MAY BE IMPLIED BY LAW (INCLUDING THE WARRANTIES OF MERCHANTABILITY AND FITNESS) IS LIMITED TO THE TERM OF THIS WARRANTY. IN NO EVENT SHALL SANYO OR THE MANUFACTURER OF THE PRODUCT BE LIABLE FOR SPECIAL, INCIDENTAL OR CONSEQUENTIAL DAMAGES ARISING FROM OWNERSHIP OR USE OF THIS PRODUCT, OR FOR ANY DALAY IN THE PERFORMANCE OF ITS OBLIGATIONS UNDER THIS WARRANTY DUE TO CAUSES BEYOND ITS CONTROL.

SOME STATES DO NOT ALLOW LIMITATIONS ON HOW LONG AN IMPLIED WARRANTY LASTS AND/OR DO NOT ALLOW THE EXCLUSION OR LIMITATION OF CONSEQUENTIAL DAMAGES, SO THE ABOVE LIMITATIONS AND EXCLUSIONS MAY NOT APPLY TO YOU.

THIS WARRANTY GIVES YOU SPECIAL LEGAL RIGHTS. YOU MAY HAVE OTHER RIGHTS, WHICH VARY FROM STATE TO STATE.

R97/10/20 (M)

For your protection in the event of theft or loss of this product, please keep the following information with a sales receipt in a safe place.

Model No. _____ **Serial No.** _____ **Date of Purchase** _____

Purchase Price _____ **Where Purchased** _____

SANYO

SANYO Manufacturing Corporation

SANYO

SANYO Electric Co., Ltd.
Printed in Thailand

J2B80201A U
03/01

